

Manufacturing Process SMJP 2113

Machining Operation

Dr.Aunglwinmoe

Senior Lecturer

Tribology and Precision Machining Laboratory

**Malaysia-Japan International Institute of
Technology**

REF: © Manufacturing Engineering and Technology, Serope Kalpakjian



Typical parts on an automobile that require machining operation

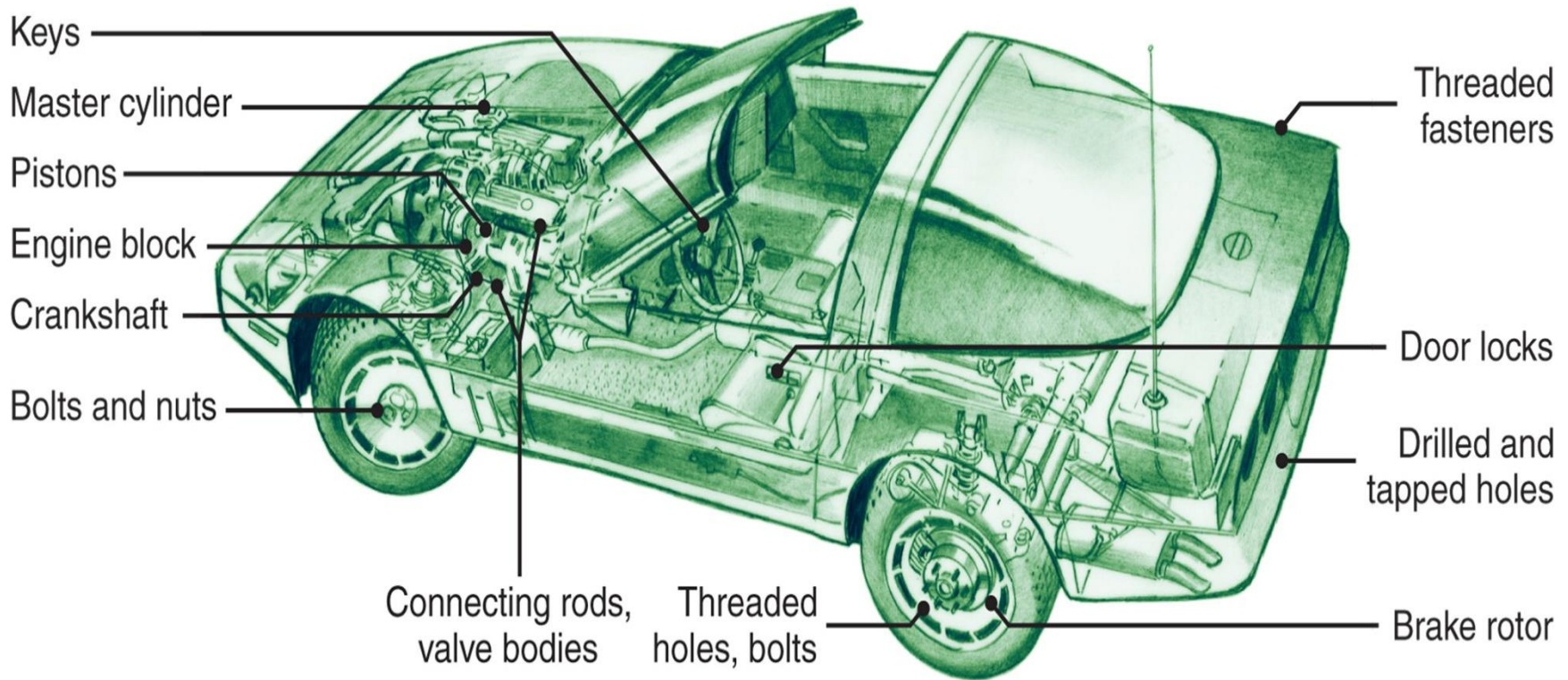

Some example of common machining operations

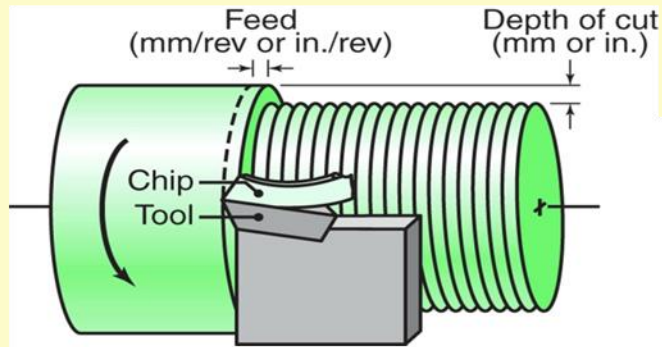

(a) Straight turning

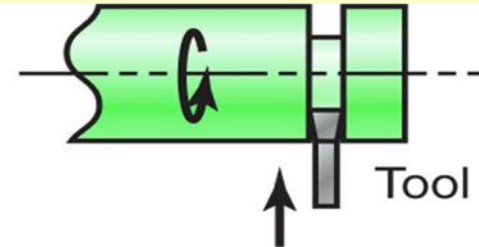

(b) Cutting off

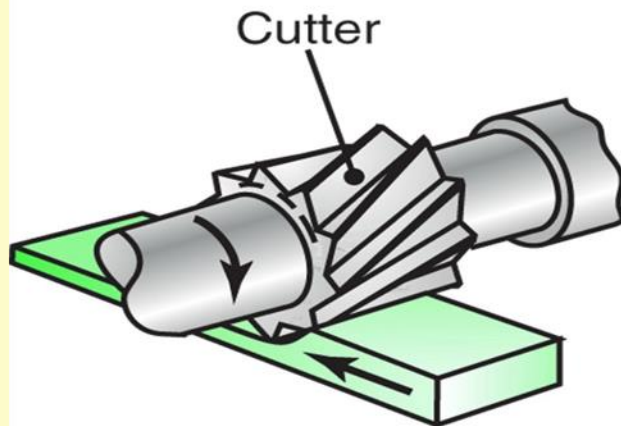

(c) Slab milling

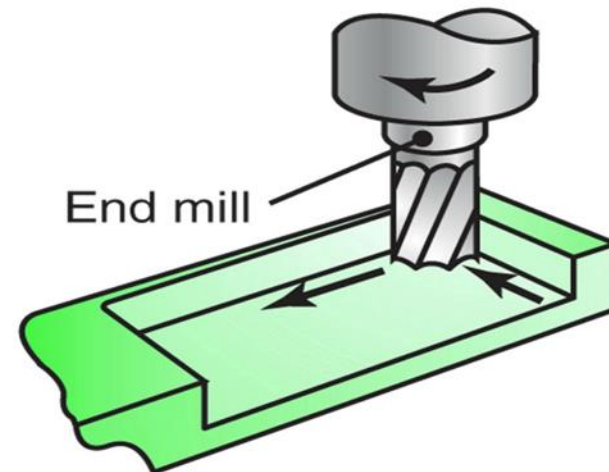

(d) End milling

Schematic illustration of a two-dimensional cutting process (orthogonal cutting- Merchant Model)

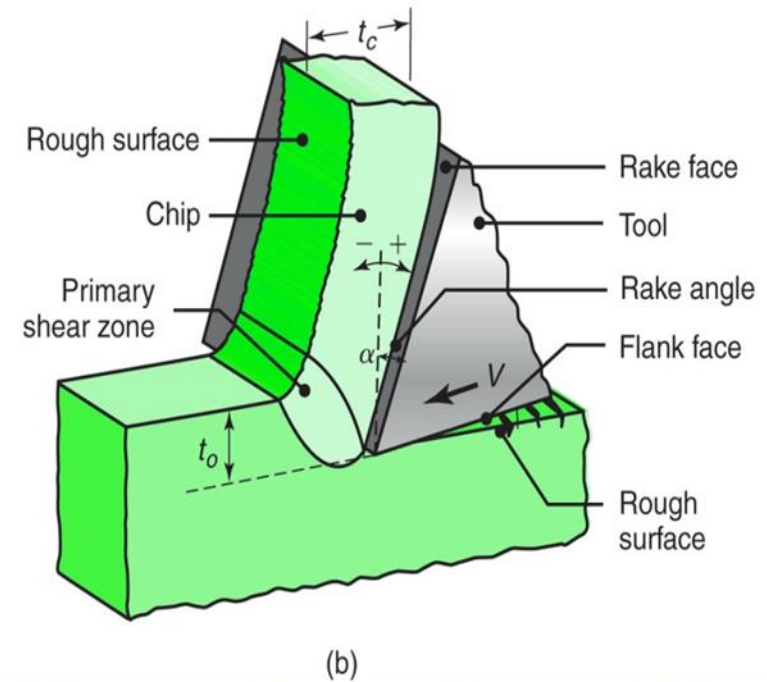
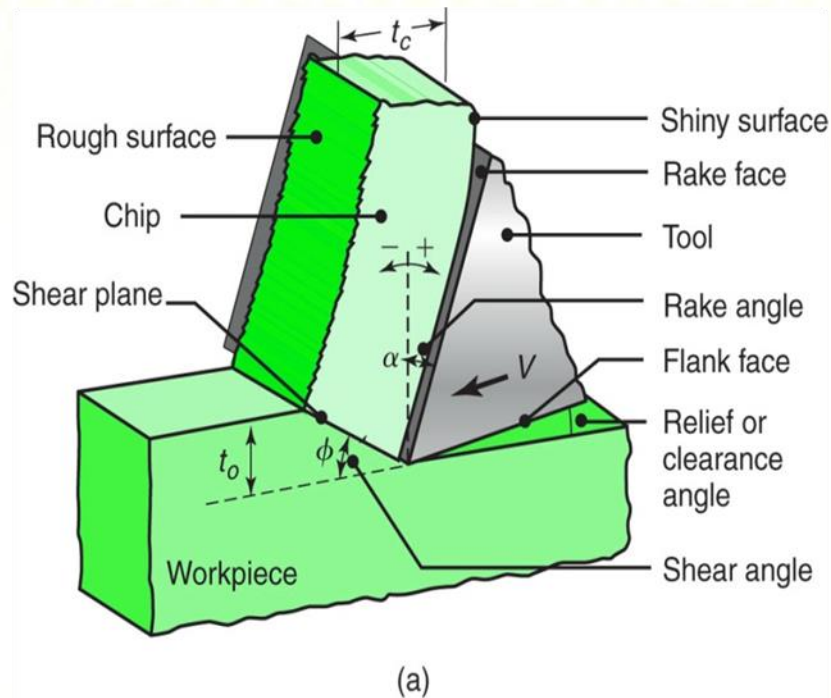

(a) Orthogonal cutting with a well-defined shear plane, Note that the tool shape, the depth of cut, t_o , and the cutting speed, V , are all independent variables. (b) Orthogonal cutting without a well-defined shear plane.

- (a) Schematic illustration of the basic mechanism of chip formation by shearing.
 (b) Velocity diagram showing angular relationships among the three speeds in the cutting zone.

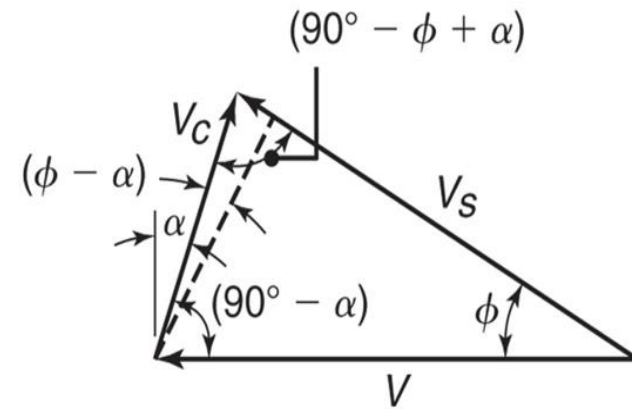
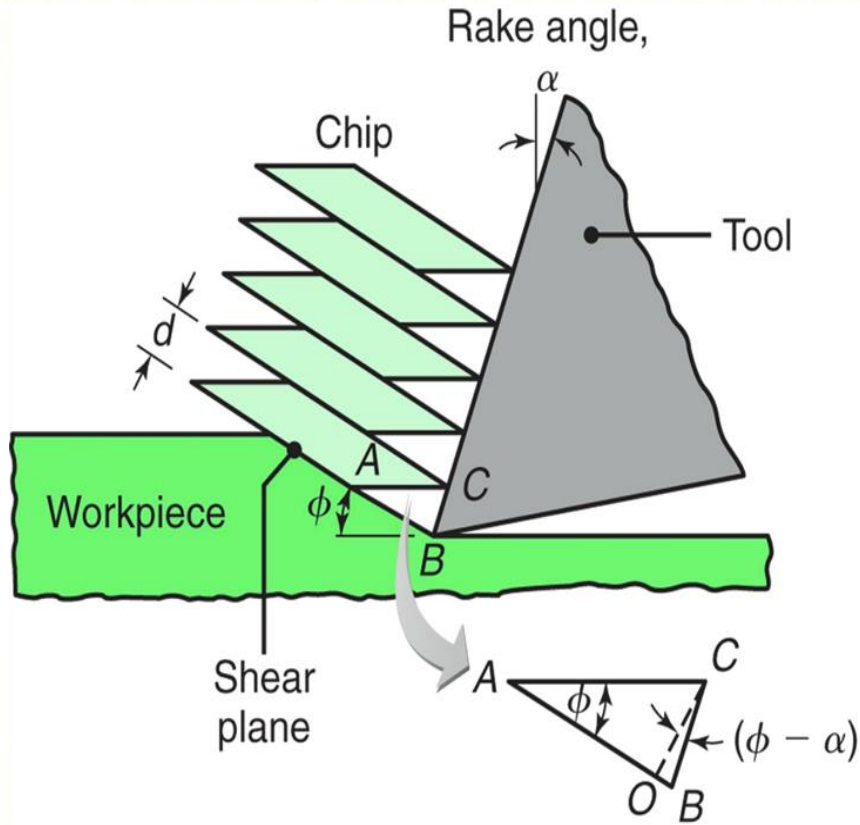

Basic types of chips produced in orthogonal metal cutting, their schematic representation, and photomicrographs of the cutting zone

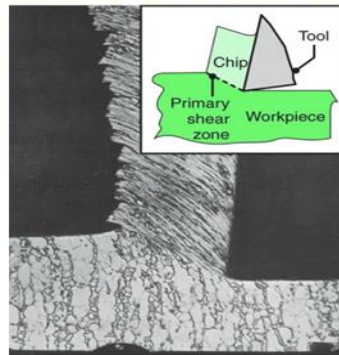

(a)

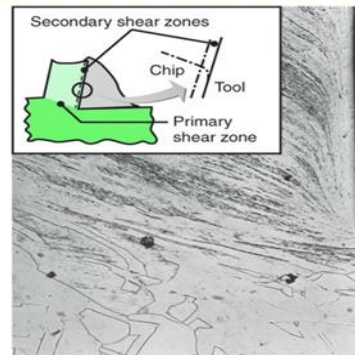

(b)

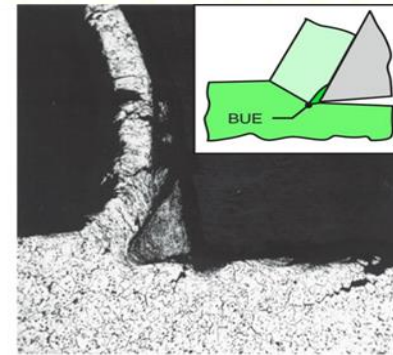

(c)

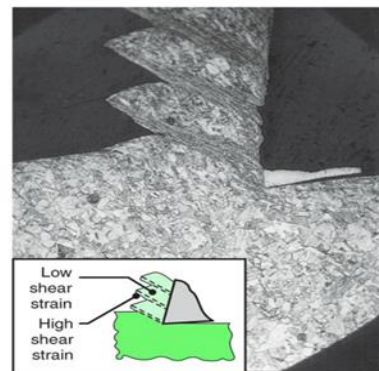

(d)

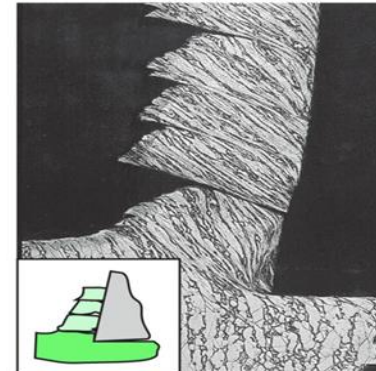

(e)

(a) continuous chip with narrow, straight, and primary shear zone; (b) continuous chip with secondary shear zone at the chip–tool interface; (c) built-up edge; (d) segmented or non homogeneous chip; and (e) discontinuous chip.

(a) Hardness distribution with a built-up edge in the cutting zone (material: 3115 steel). Note that some regions in the built-up edge are as much as three times harder than the bulk metal of the work piece. (b) Surface finish produced in turning 5130 steel with a built-up edge. (c) Surface finish on 1018 steel in face milling. Magnifications: 15x

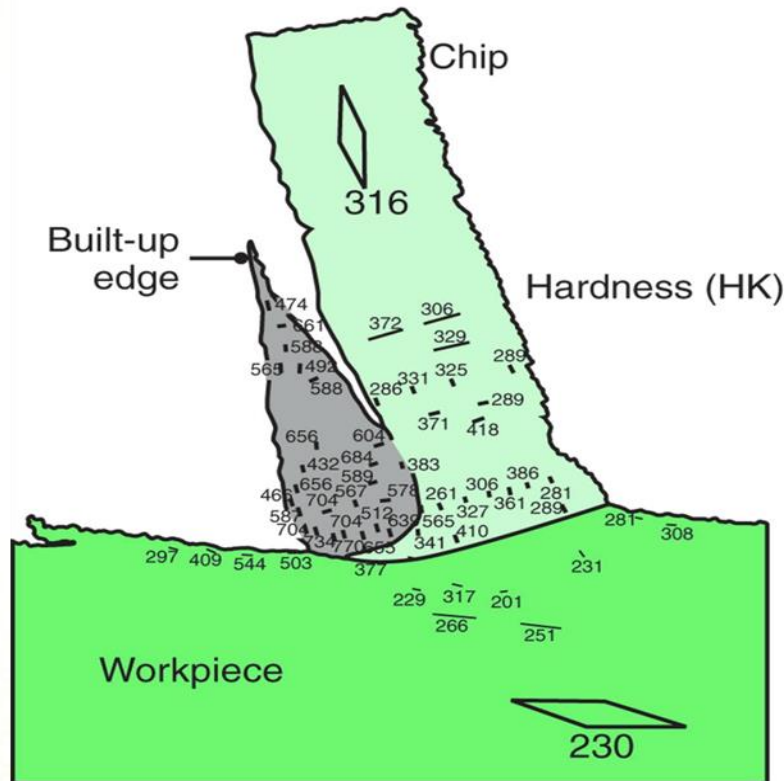

(a)

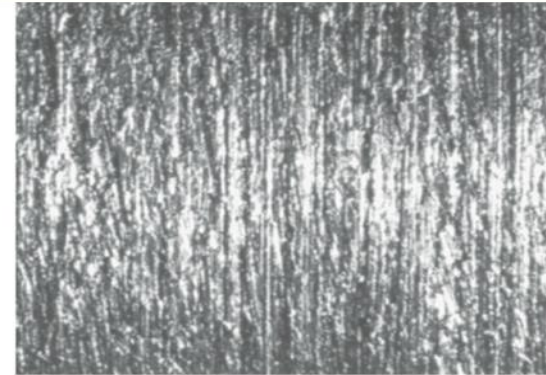

(b)



(c)

(a) Forces acting in the cutting zone during two-dimensional cutting. Note that the resultant force, R , must be co linear to balance the forces. (b) Force circle to determine various forces acting in the cutting zone.

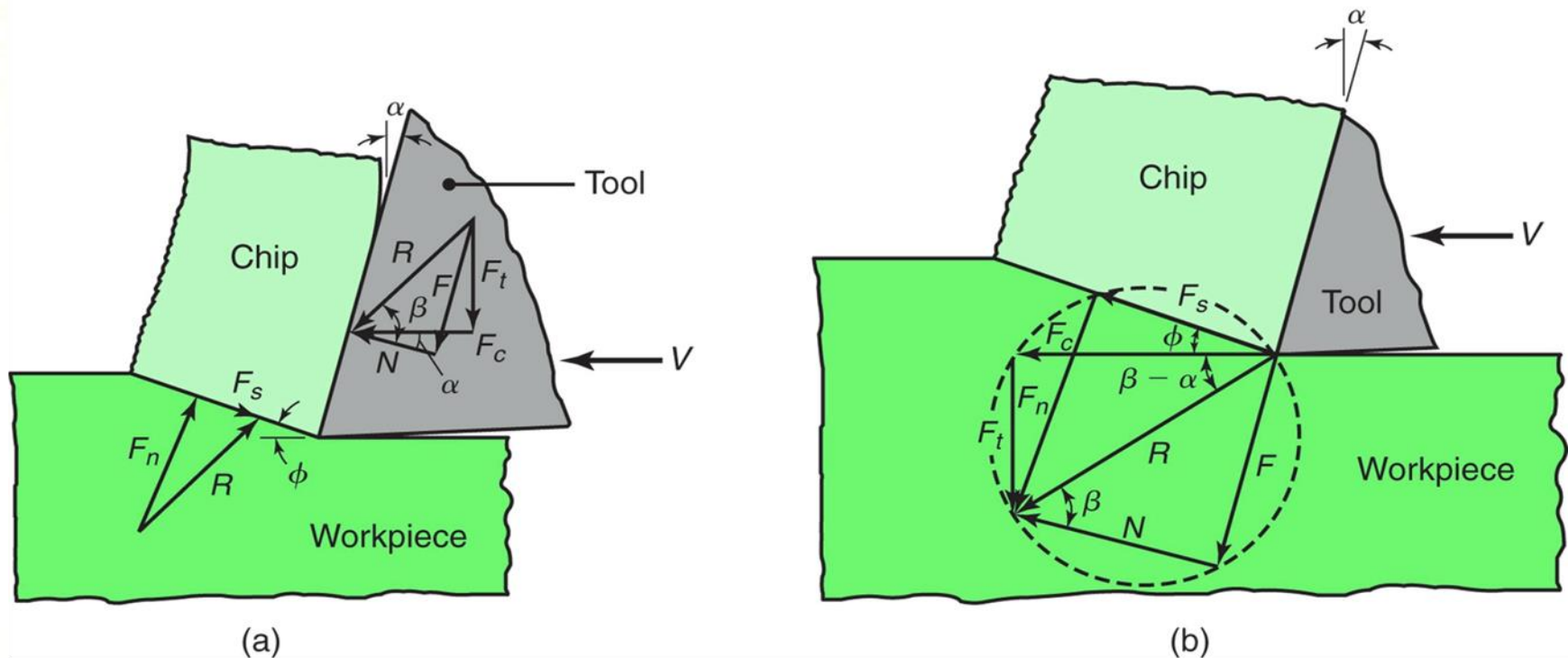

F_c = cutting force
 V = cutting speed
 F_t = thrust force
 R = resultant force
 F = friction force

N = normal force
 F_s = shear force
 F_n = normal force
 β = friction angle
 ϕ = shear plane angle

Typical temperature distribution in the cutting zone

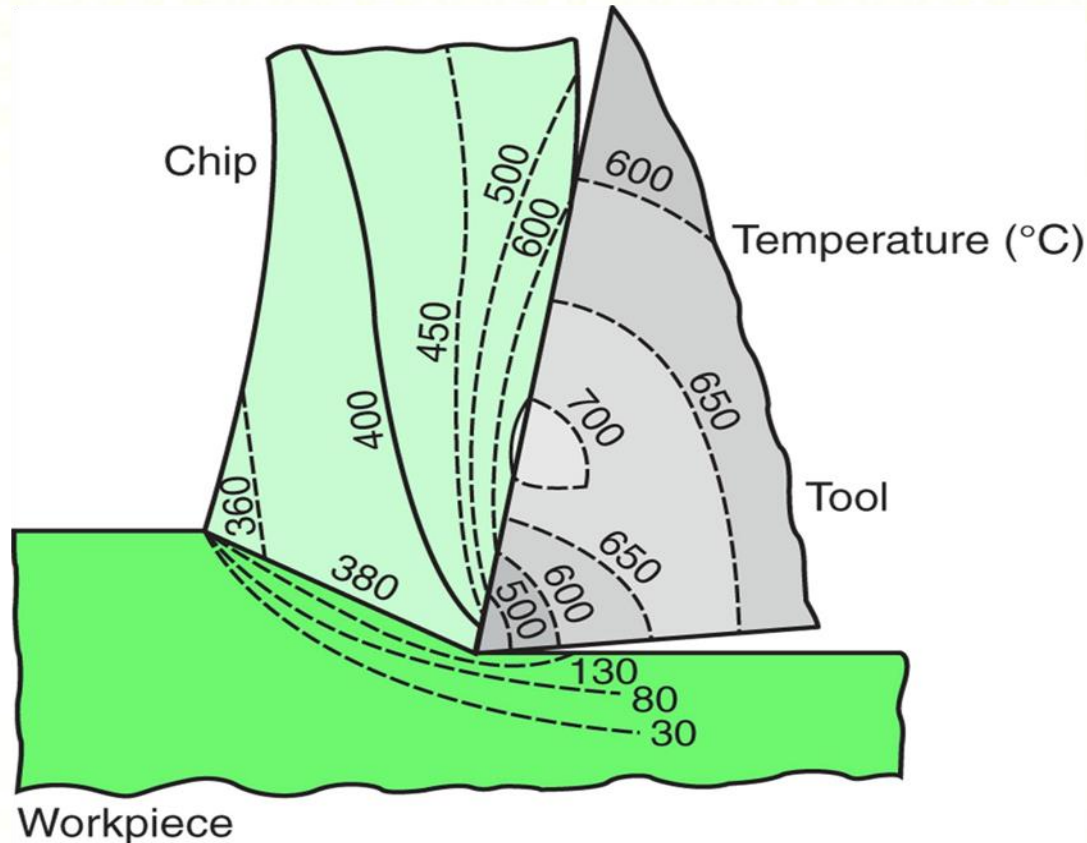

Note the severe temperature gradients within the tool and the chip, and that the work piece is relatively cool.

Temperatures developed in turning 52100 steel: (a) flank temperature distribution and (b) tool–chip interface temperature distribution.

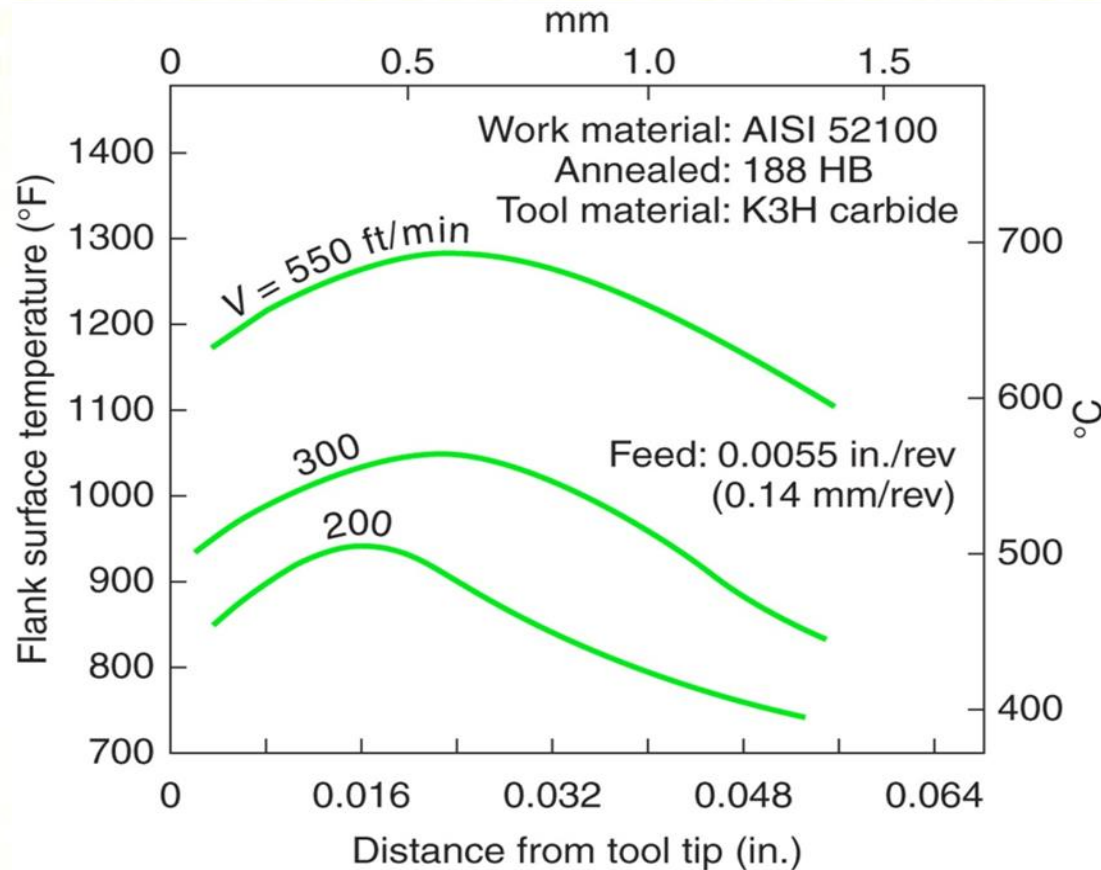

(a)

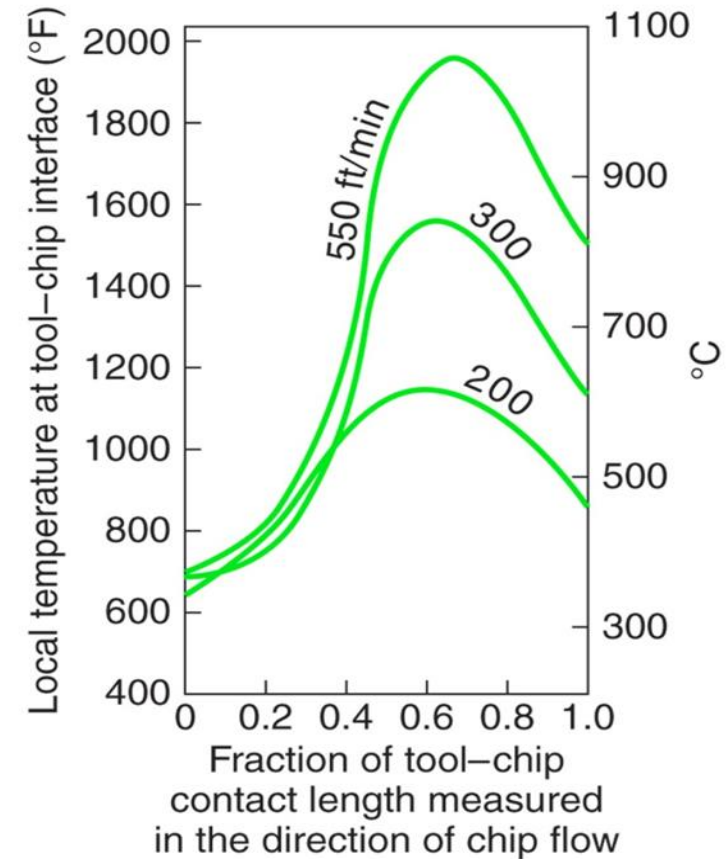

(b)

Schematic illustration of a dull tool with respect to the depth of cut in orthogonal machining

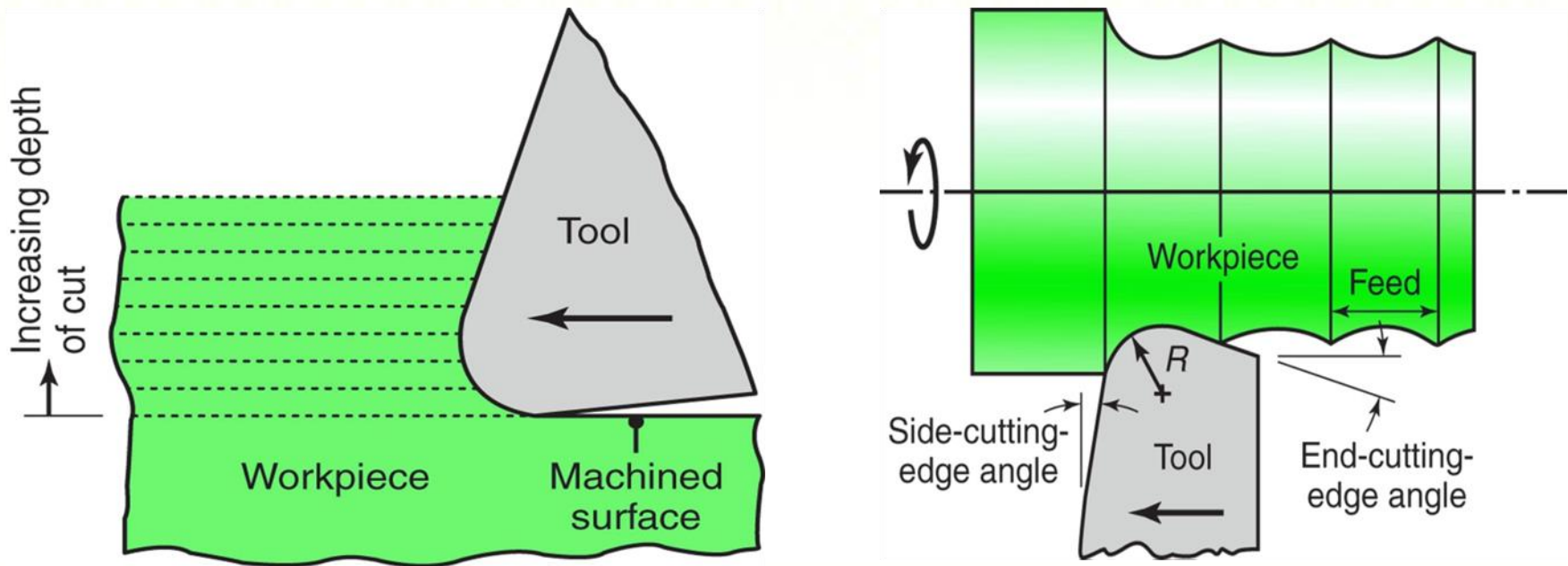

Note that the tool has a positive rake angle, but as the depth of cut decreases, the rake angle effectively can become negative. The tool then simply rides over the work piece (without cutting) and burnishes its surface; this action raises the work piece temperature and causes surface residual stresses.

Multiphase coatings on a tungsten-carbide substrate. Three alternating layers of aluminum oxide are separated by very thin layers of titanium nitride. Inserts with as many as 13 layers of coatings have been made. Coating thicknesses are typically in the range from 2 to 10 μm .

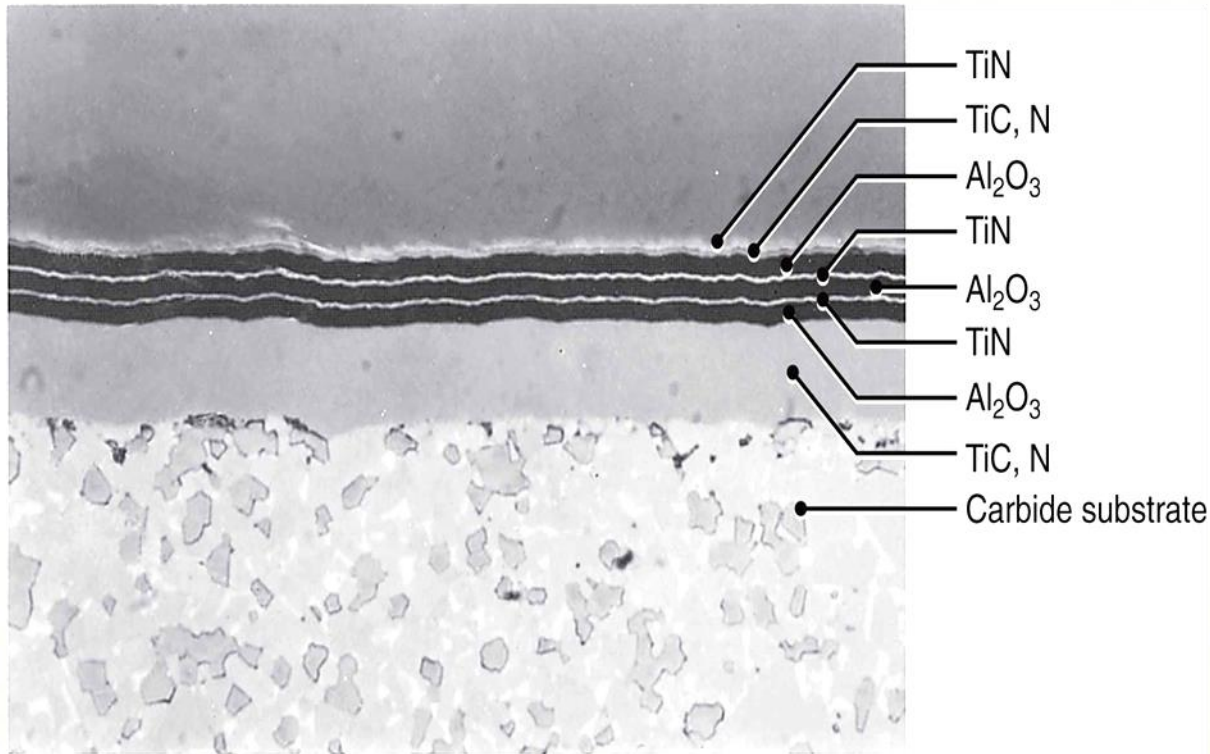

Designations for a right-hand cutting tool. *Right-hand* means that the tool travels from right to left, as shown in Fig.

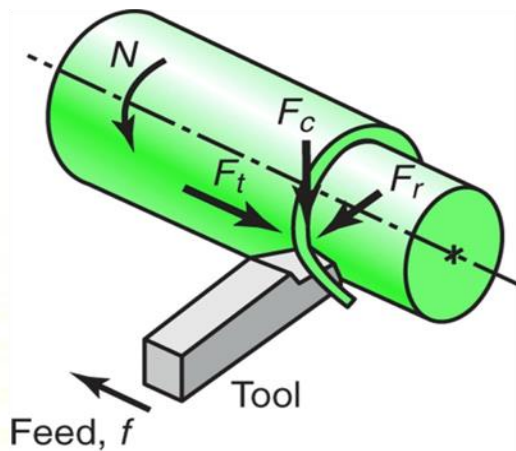
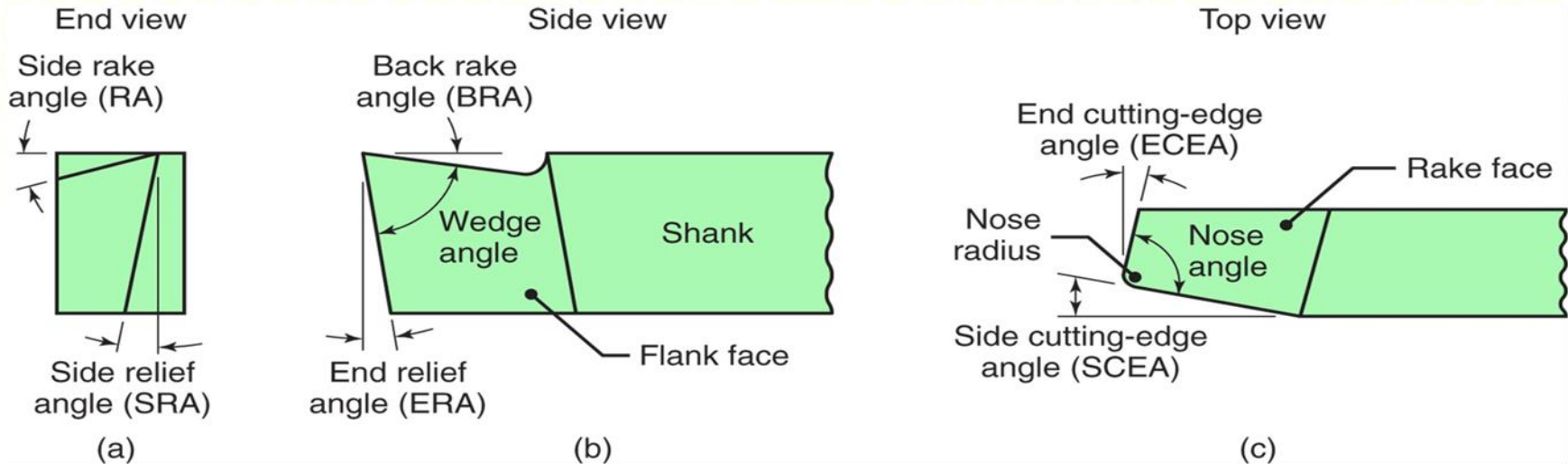

Forces acting on a cutting tool in turning. F_c is the cutting force, F_t is the thrust or feed force (in the direction of feed), and F_r is the radial force that tends to push the tool away from the work piece being machined.

Various types of drills and drilling and reaming operations

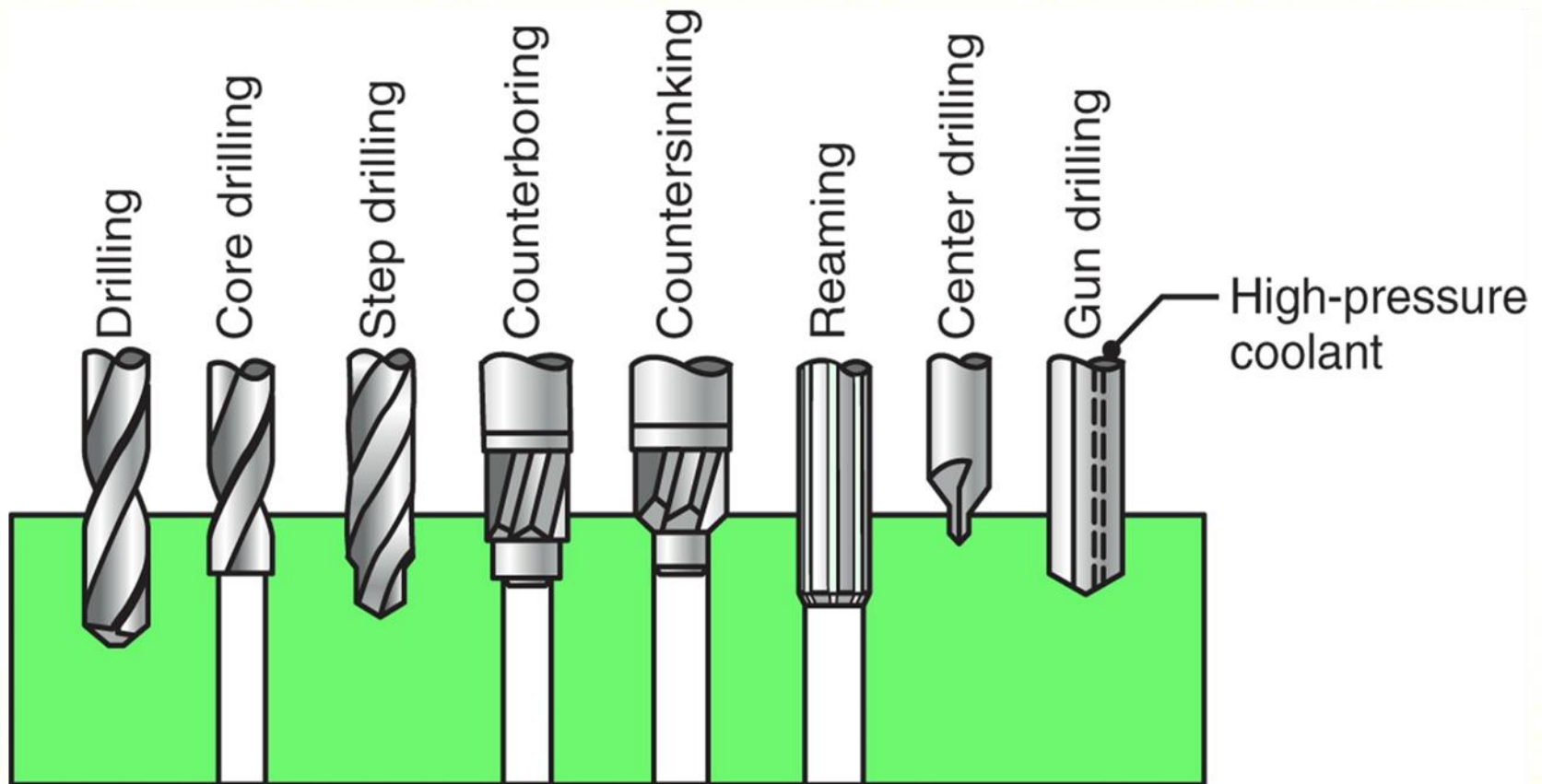

Some basic types of milling cutters and milling operations

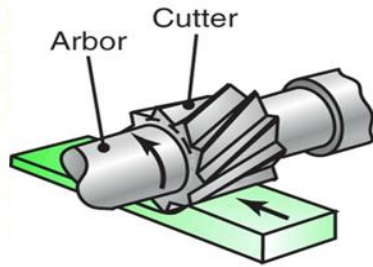

(a) Peripheral milling

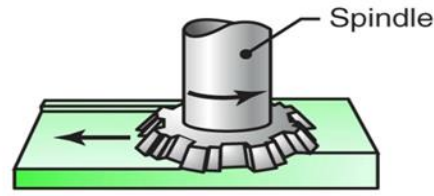

(b) Face milling

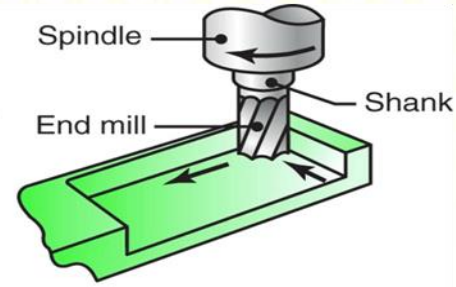

(c) End milling

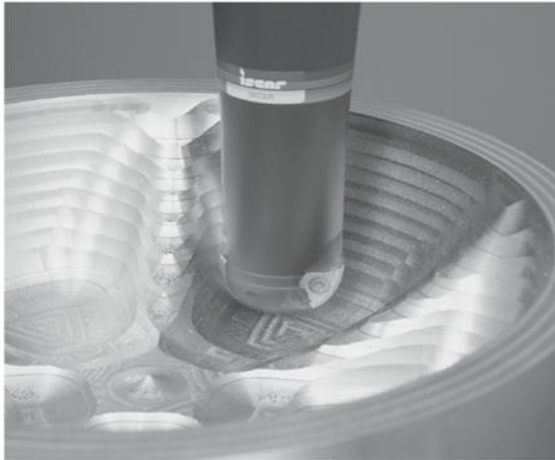

(d)



(e)

(a) Peripheral milling. (b) Face milling. (c) End milling. (d) Ball-end mill with indexable coated-carbide inserts machining a cavity in a die block. (e) Milling a sculptured surface with an end mill using a five-axis numerical control machine. *Source:* (d) Courtesy of Iscar Metals, Inc. (e) Courtesy of The Ingersoll Milling Machine Co.

(a) conventional milling and climb milling. (b) Slab milling operation showing depth of cut, d ; feed per tooth, f ; chip depth of cut, t_c ; and work piece speed, v . (c) Schematic illustration of cutter travel distance, l_c , to reach full depth of cut.

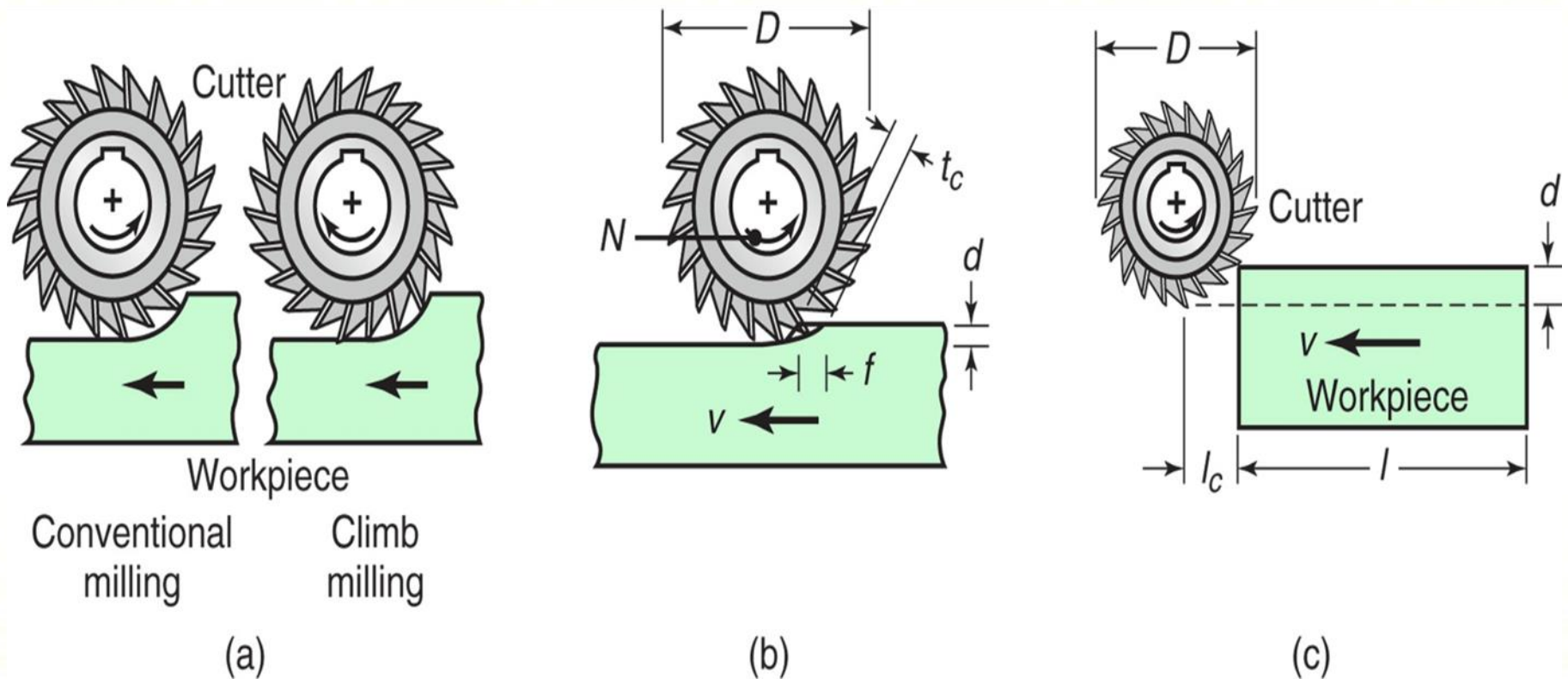

(a) Face-milling operation, showing action of an insert; (b) climb milling; (c) conventional milling; (d) dimensions in face milling. The width of cut, w , is not necessarily the same as the cutter radius.

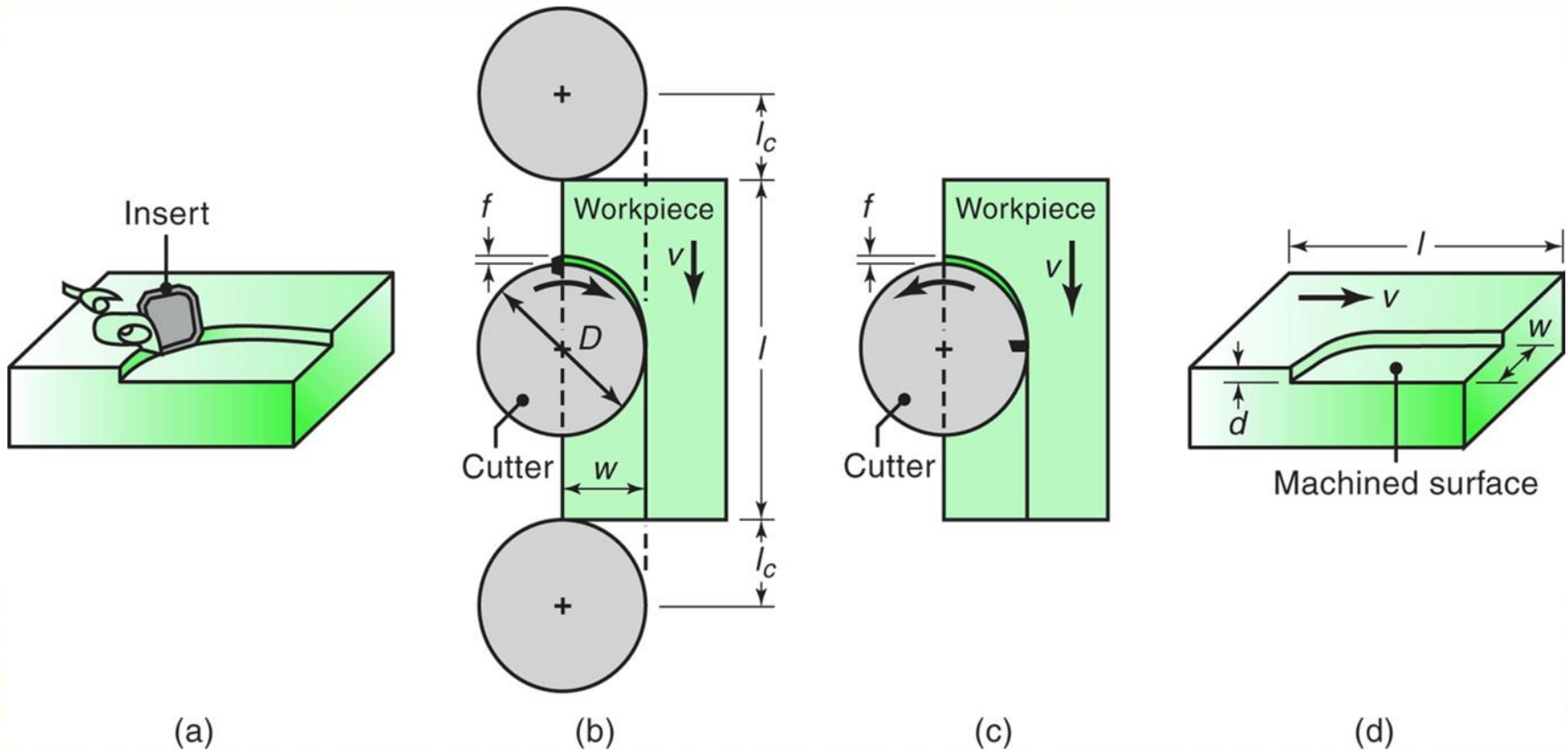

Schematic illustration of the effect of insert shape on feed marks on a face milled surface

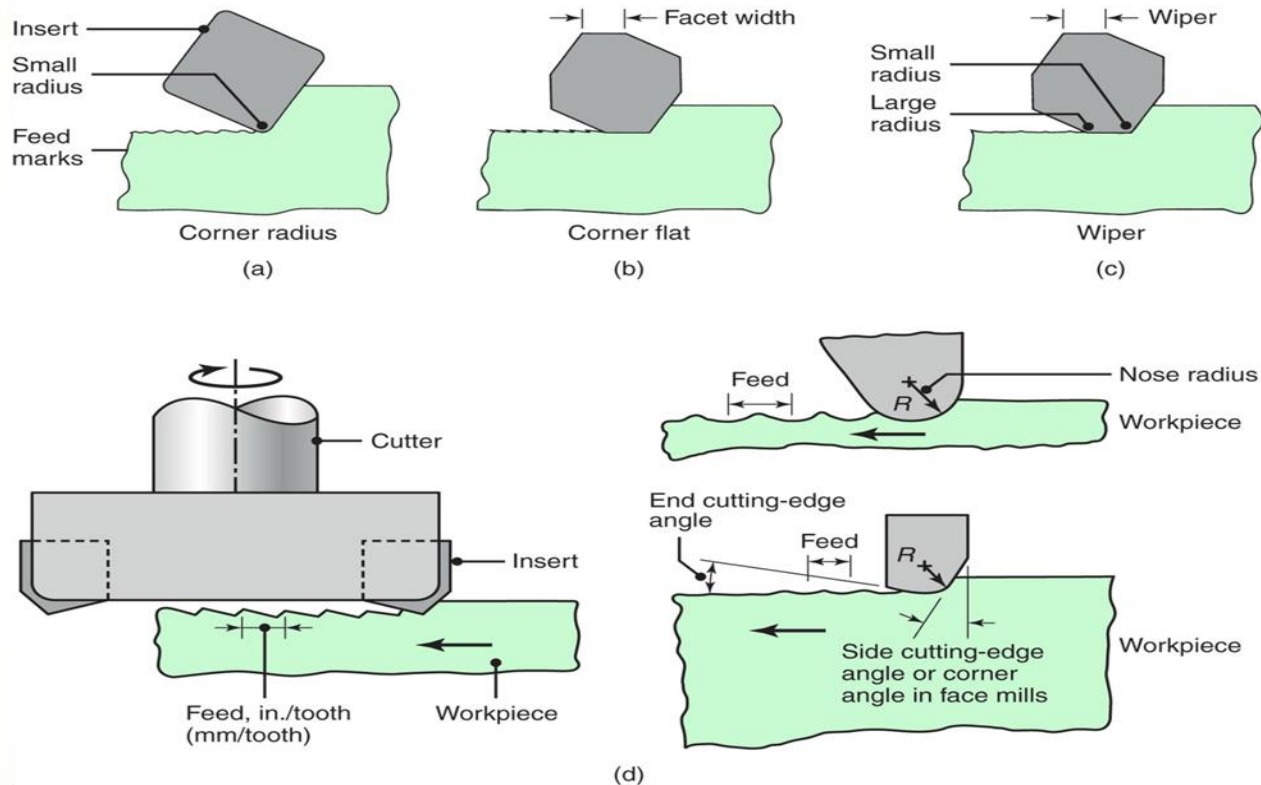

(a) small corner radius, (b) corner flat on insert, and (c) wiper, consisting of a small radius followed by a large radius, resulting in smoother feed marks. (d) Feed marks due to various insert shapes.

- (a) Cutting action of a broach, showing various features.
 (b) Terminology for a broach.

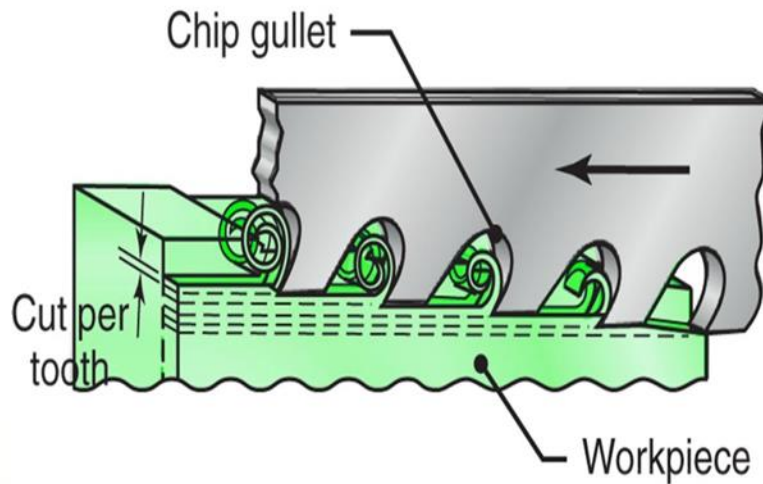

(a)

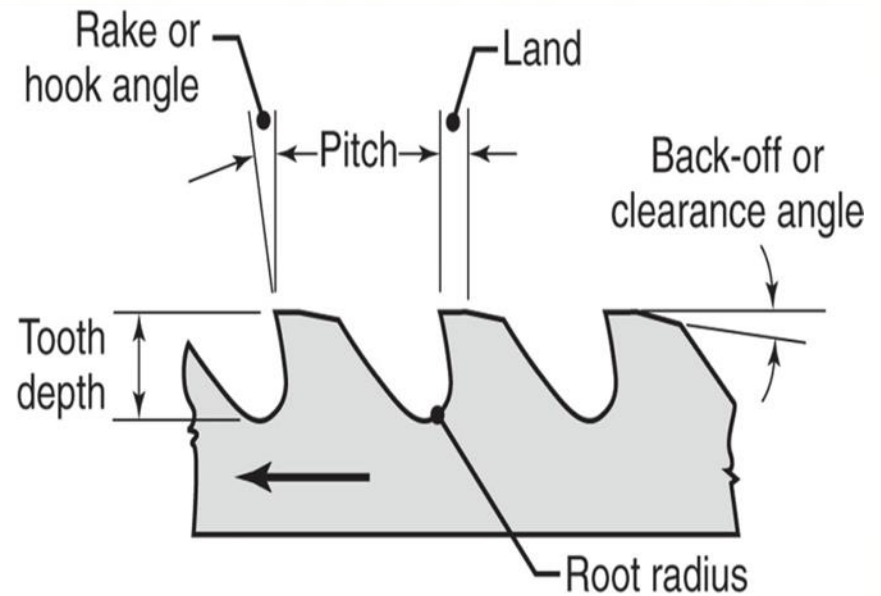

(b)

- (a) Schematic illustration of gear cutting with a hob.
 (b) Production of a worm gear by hobbing.

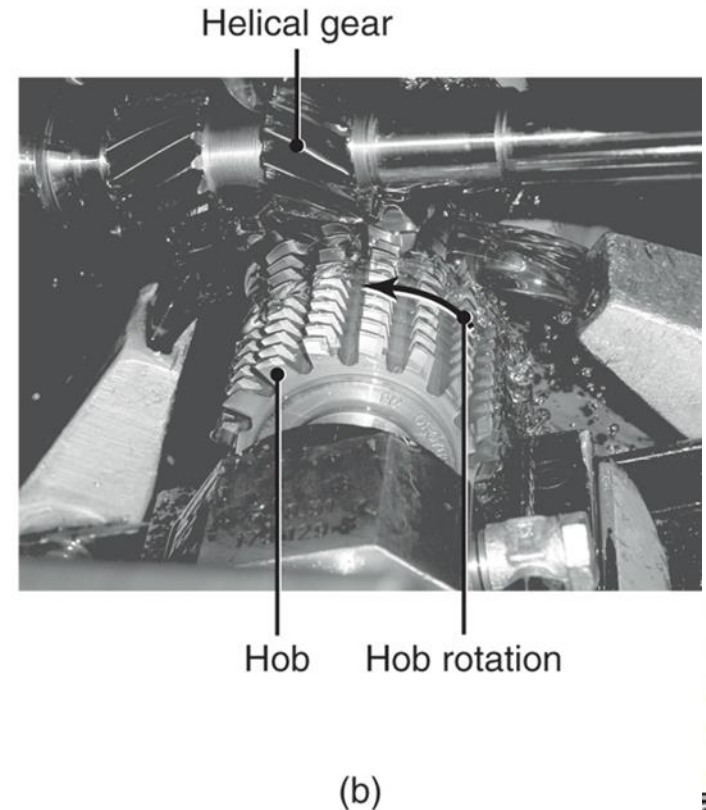
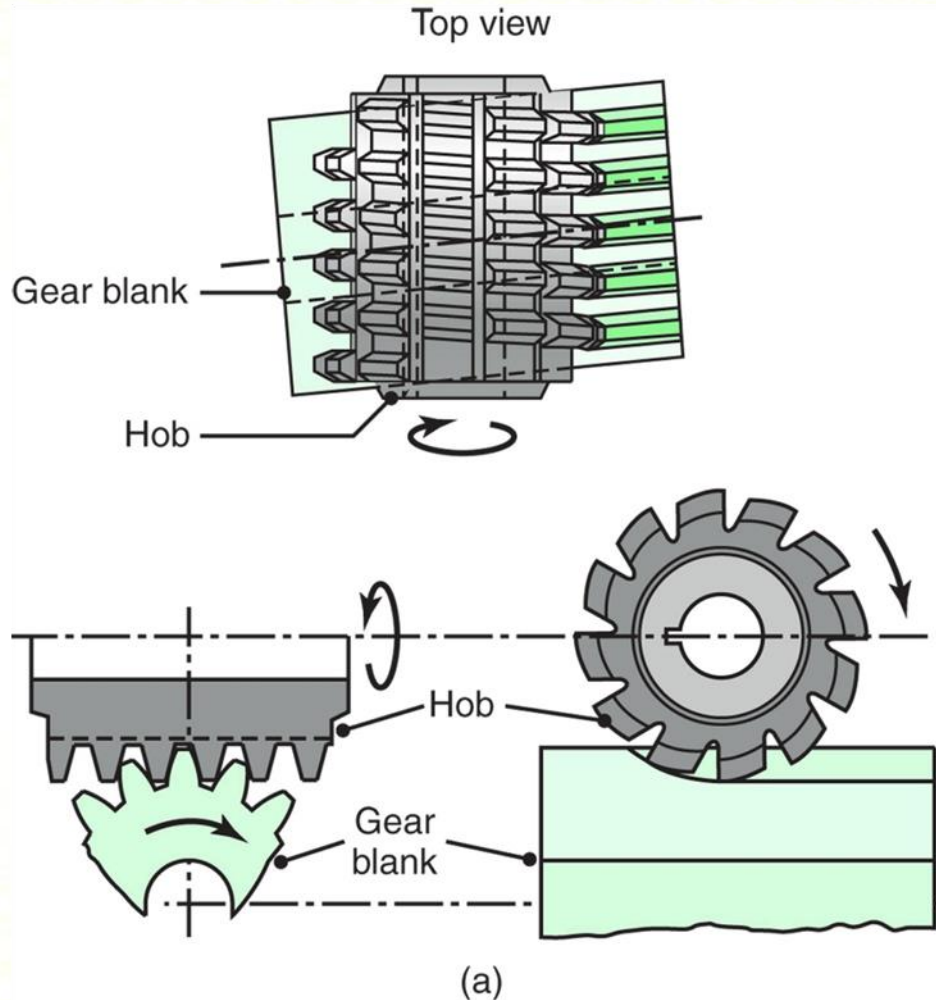

A vertical-spindle machining center. The tool magazine is on the left of the machine. The control panel on the right can be swiveled by the operator.

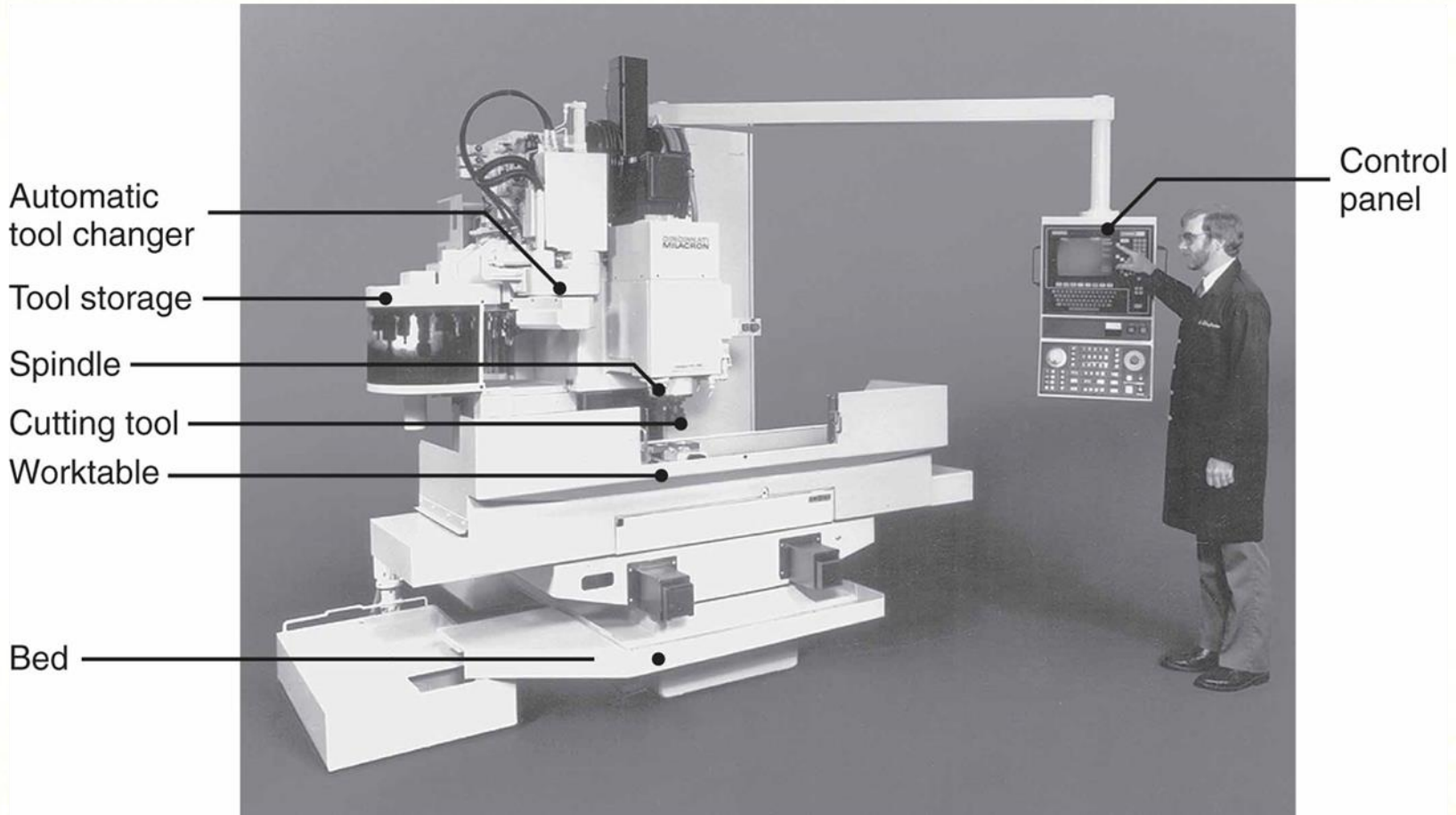

Schematic illustration of a computer numerical-controlled turning center. The two spindle heads and three turret heads make the machine very flexible in its machining capabilities.

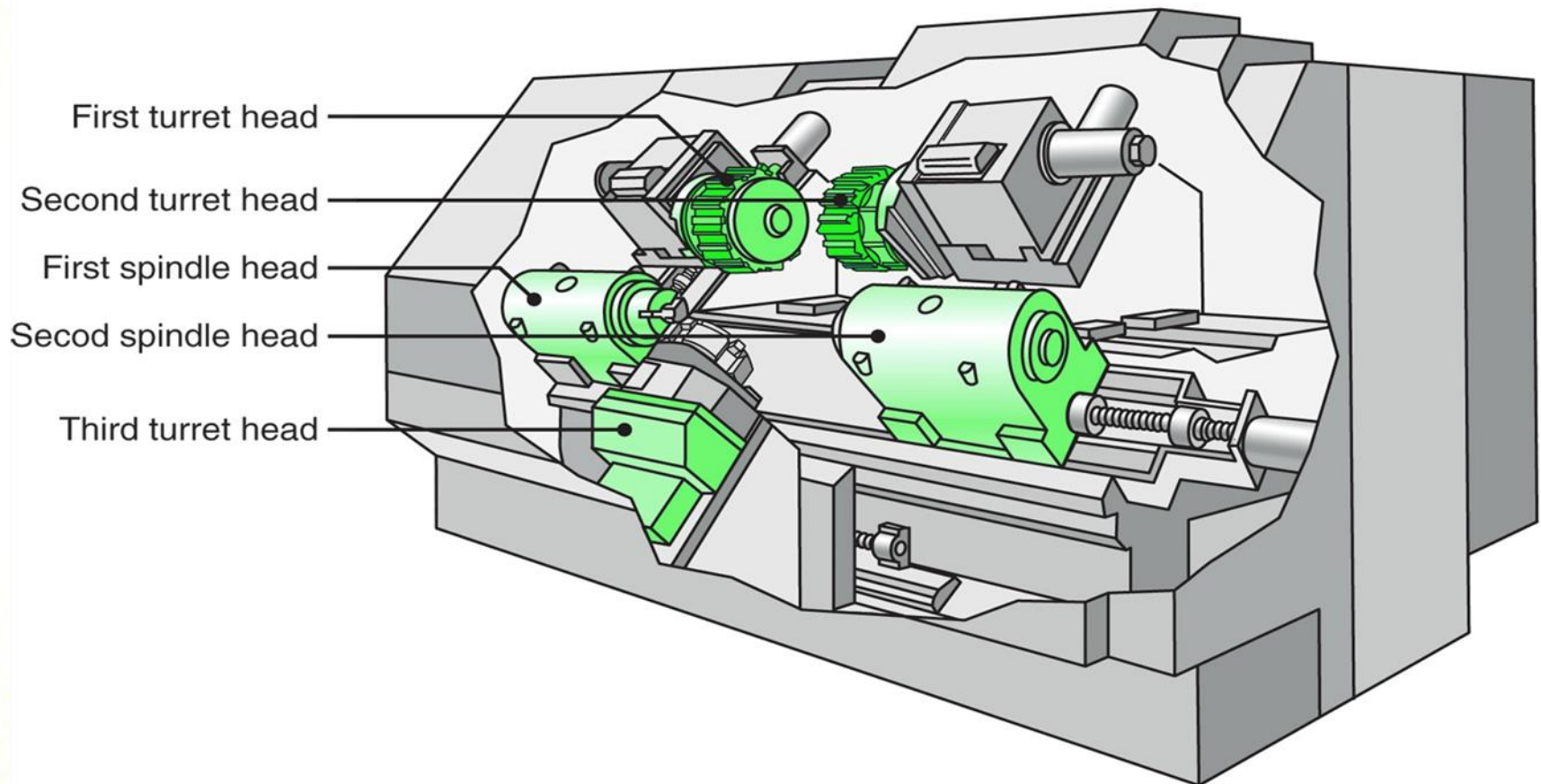

Machining of outer bearing races

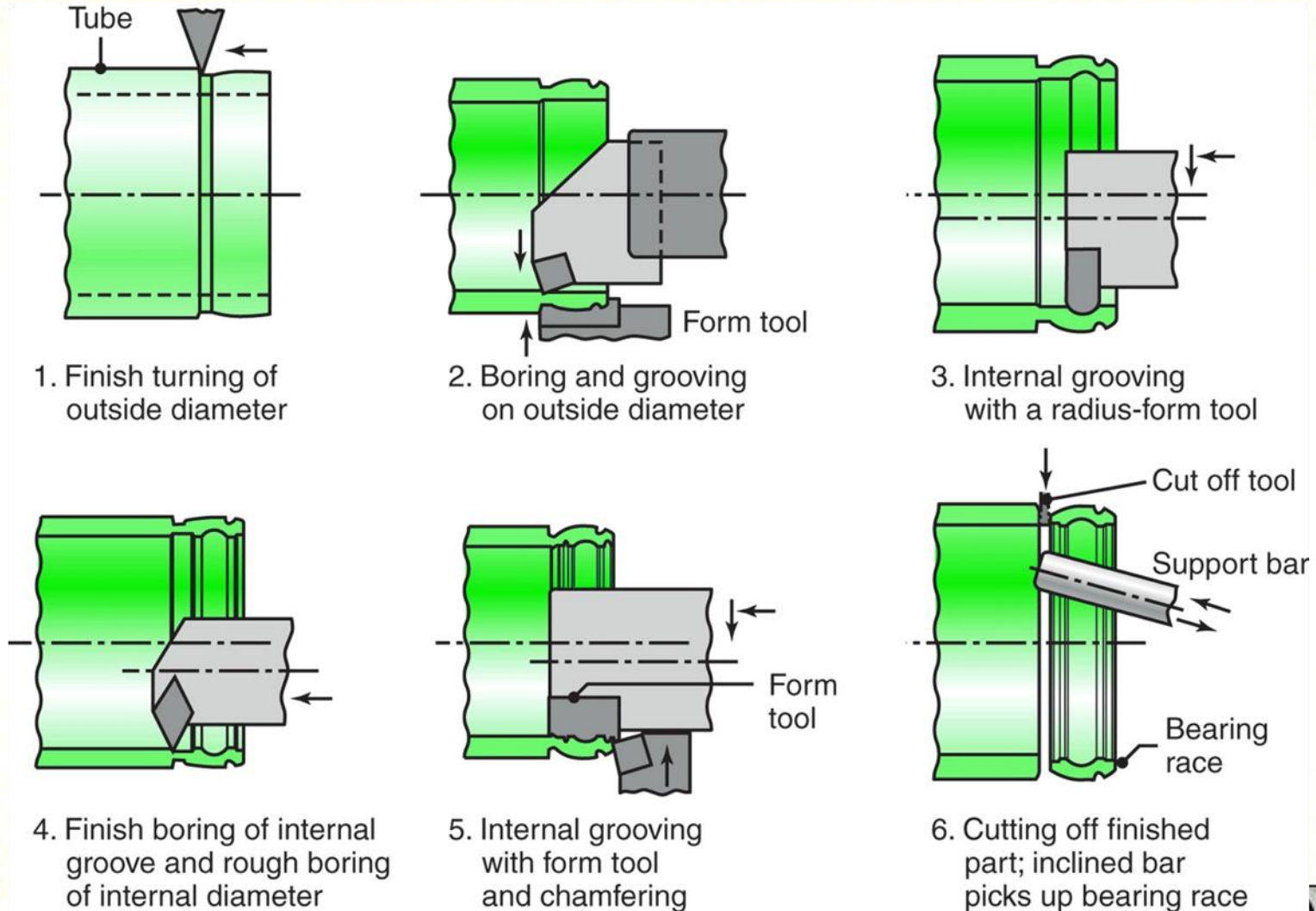

(a) A hexapod machine tool, showing its major components. (b) A detailed view of the cutting tool in a hexapod machining center.



(a)

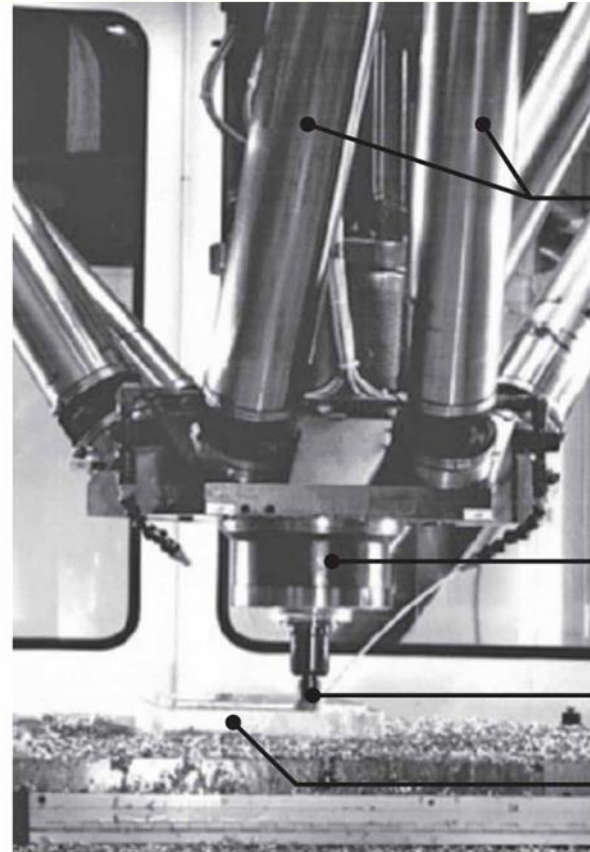

(b)

Hexapod
legs

Spindle

Cutting tool

Workpiece

Chatter marks on the surface of a turned part

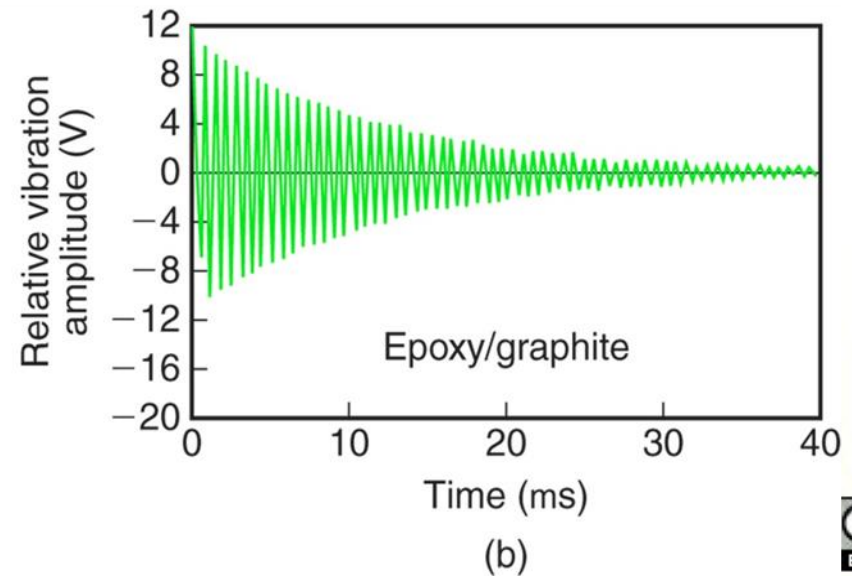
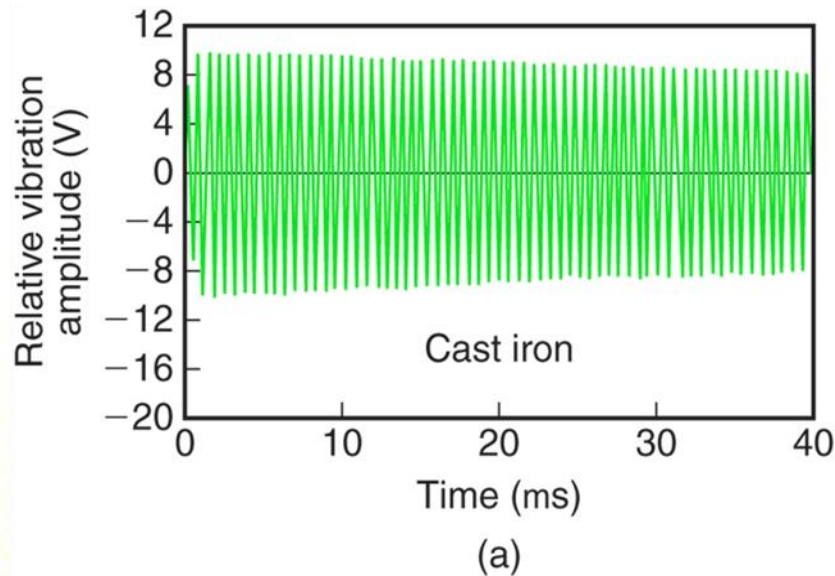
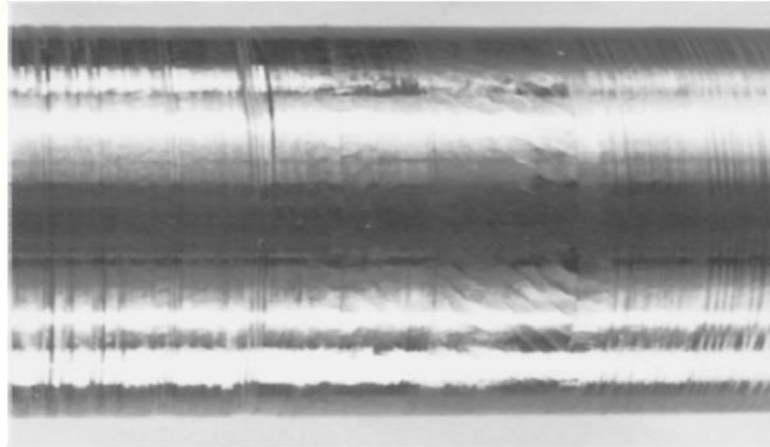

Improvements in machining accuracy by ultra precision machining technologies

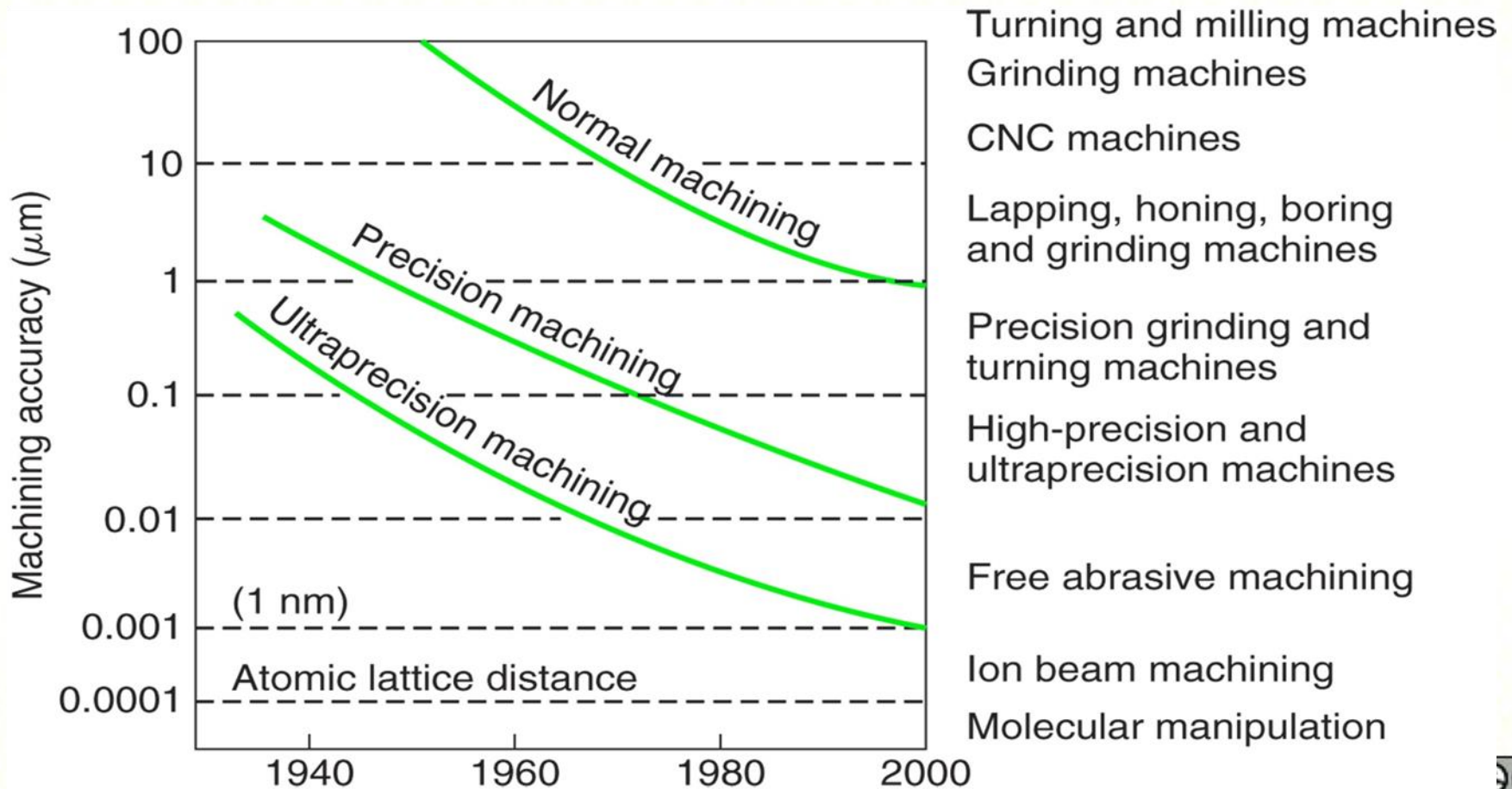

High efficiency machining range

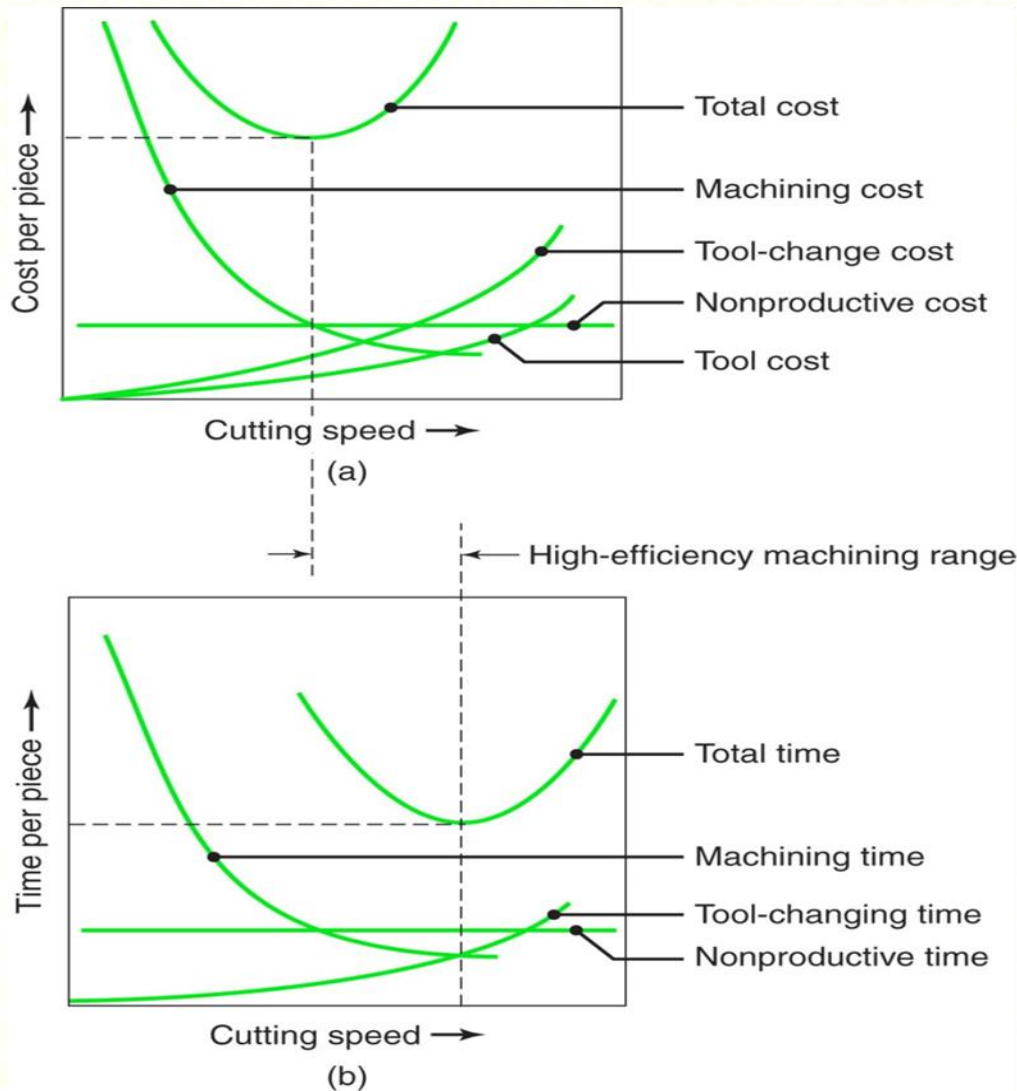

(a) cost per piece and
(b) time per piece in machining.

THANK YOU