

Prestressed Concrete Design (SAB 4323)

Deflections

Assoc. Prof. Baderul Hisham Ahmad



Introduction

- The effect of deflection in a structure varies according to the use of the structure.
- Excessive deflections may lead to sagging floors, to roof that do not drain properly, to damage partitions and finishes, to the creation of pools of water on road surface of bridges, and to other associated troubles

Deflection of PSC Beam

- Fully prestressed concrete members (class 1 and class 2) remain crack-free under service load
- Can be assumed linearly elastic
- Two types of deflection
 - Short-term or instantaneous
 - Long-term
- Short-term deflection occurs immediately upon the application of a load (caused by elastic deformation of the concrete in response to loading)
- Long-term deflection takes into account the long-term shrinkage and creep movements (time-dependent)

Deflection of PSC Beam

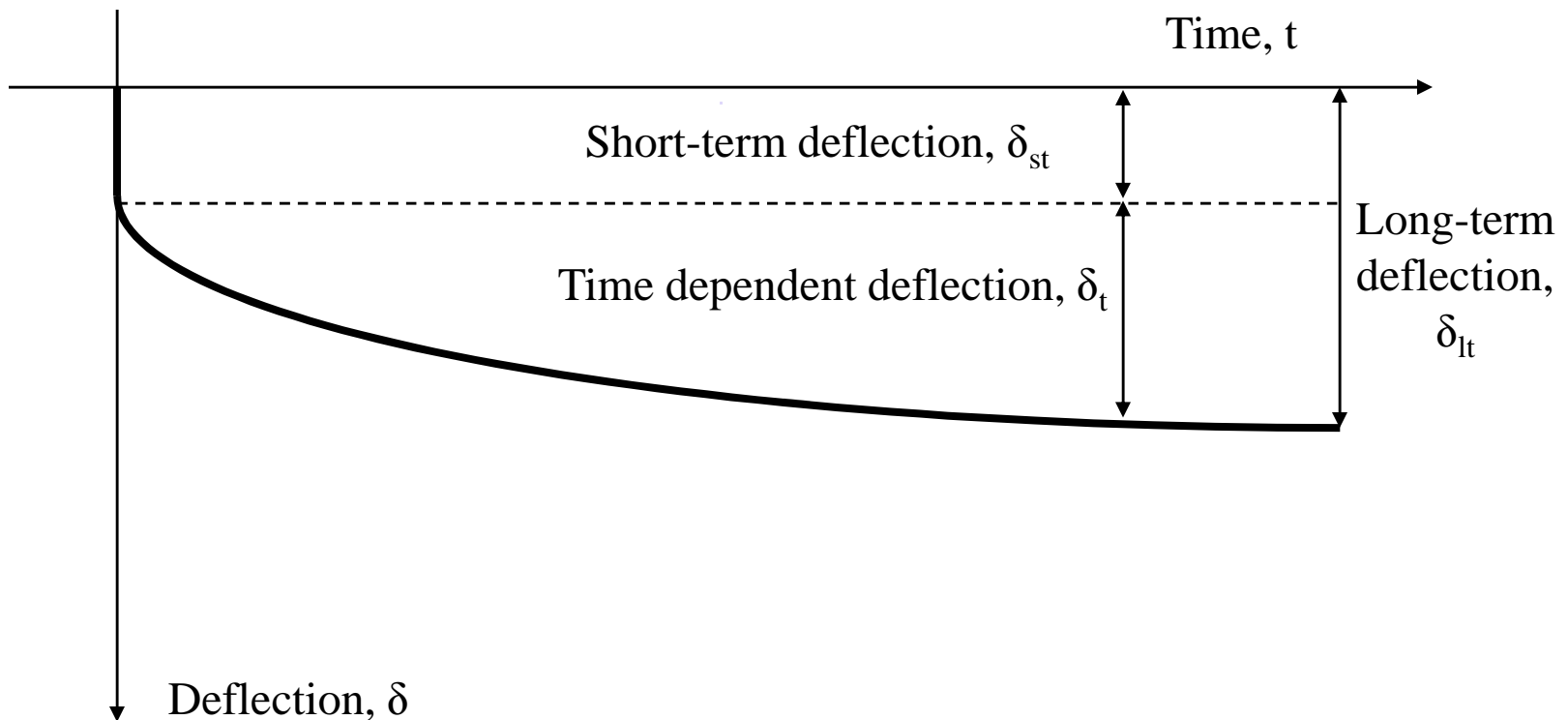

Deflection of PSC Beam

- Due to external loads
- Due to prestressed force
- Can use various methods to calculate deflections
 - Double Integration Method (McCauley)
 - Moment Area Method
 - Conjugate Beam Method
 - Principle of Virtual Load

Short-term Deflection

Due to Vertical Loads

Due to Prestress Force, P

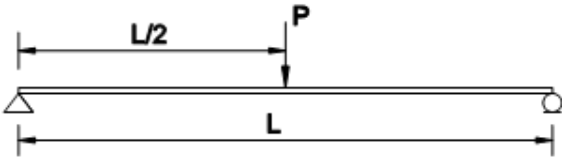
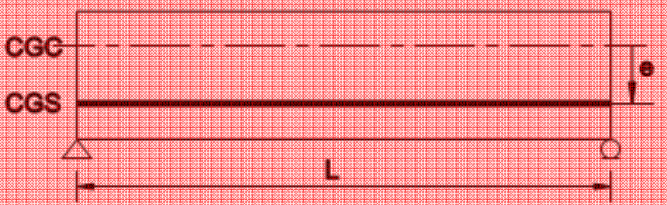
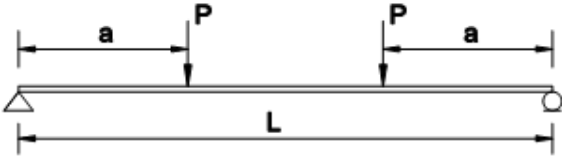
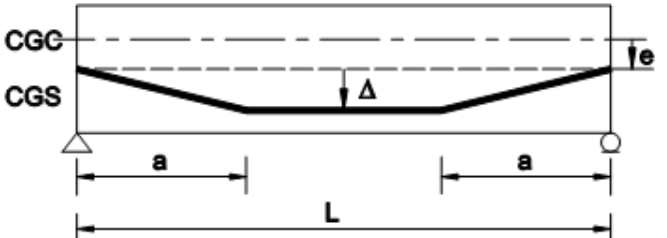
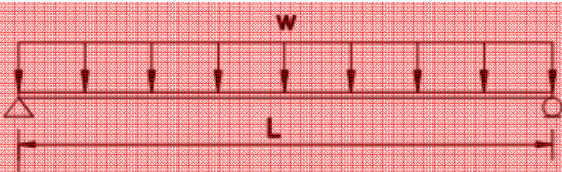
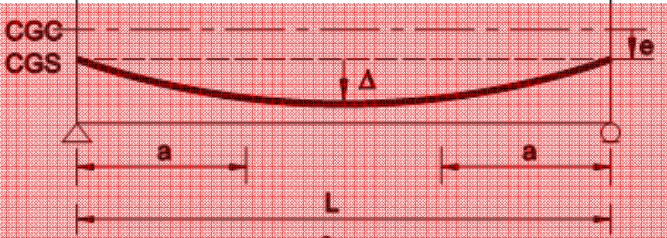
 $\delta = \frac{PL^3}{48EI}$	 $\delta = -\frac{PeL^2}{8EI}$
 $\delta = \frac{Pa}{24EI} (3L^2 - 4a^2)$	 $\delta = -\frac{PL^2}{8EI} [e + \Delta - 4\Delta a^2/3L^2]$
 $\delta = \frac{5wL^4}{384EI}$	 $\delta = -\frac{PL^2}{8EI} [e + 5\Delta/6]$

Short-term Deflection

Commonly
Used in M'sia

Due to Vertical Loads

Due to Prestress Force, P

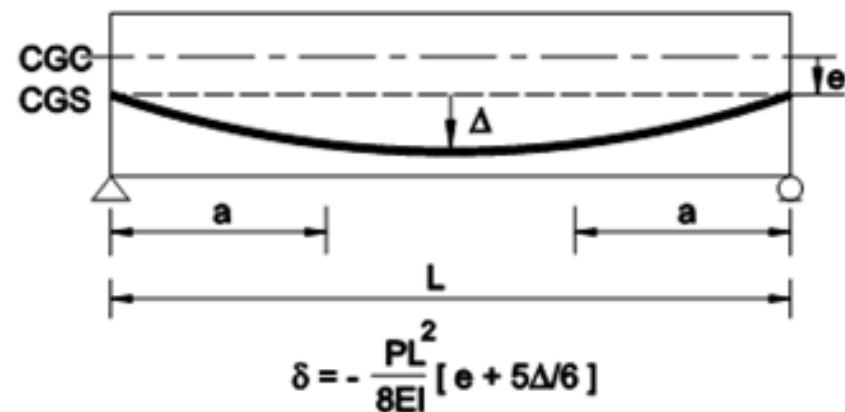
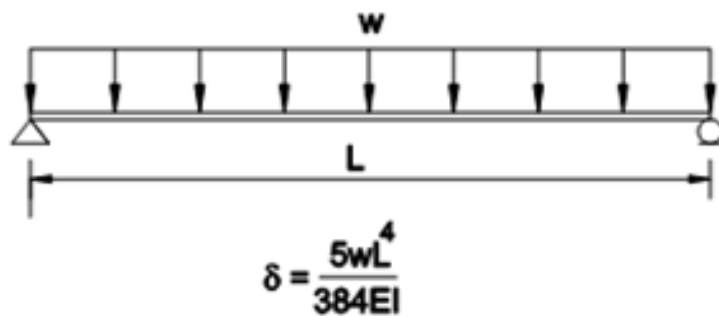
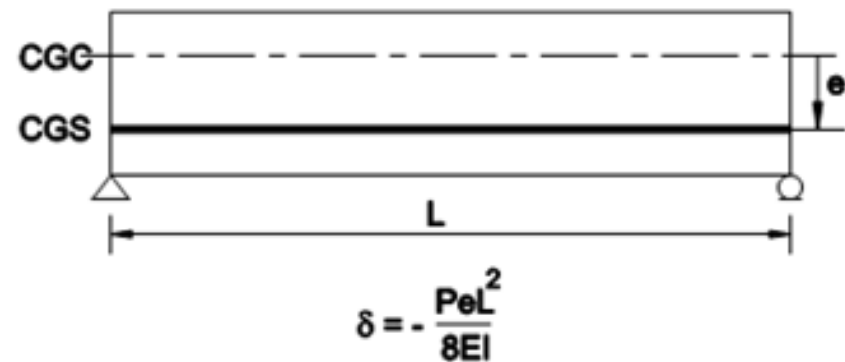
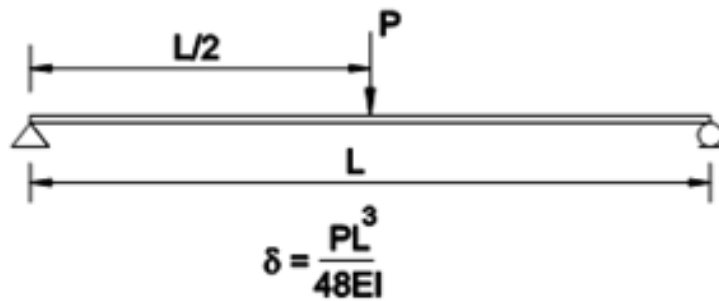

Example 4-1

Determine the midspan deflection of the beam shown below: (i) at transfer with an inertial prestress force of 6800kN; (ii) under an imposed load of 30 kN/m when the prestress force has been reduced to 4500 kN. Take self weight of beam = 11.26 kN/m; $I = 0.006396\text{m}^4$; $E = 28 \times 10^6 \text{ kN/m}^2$

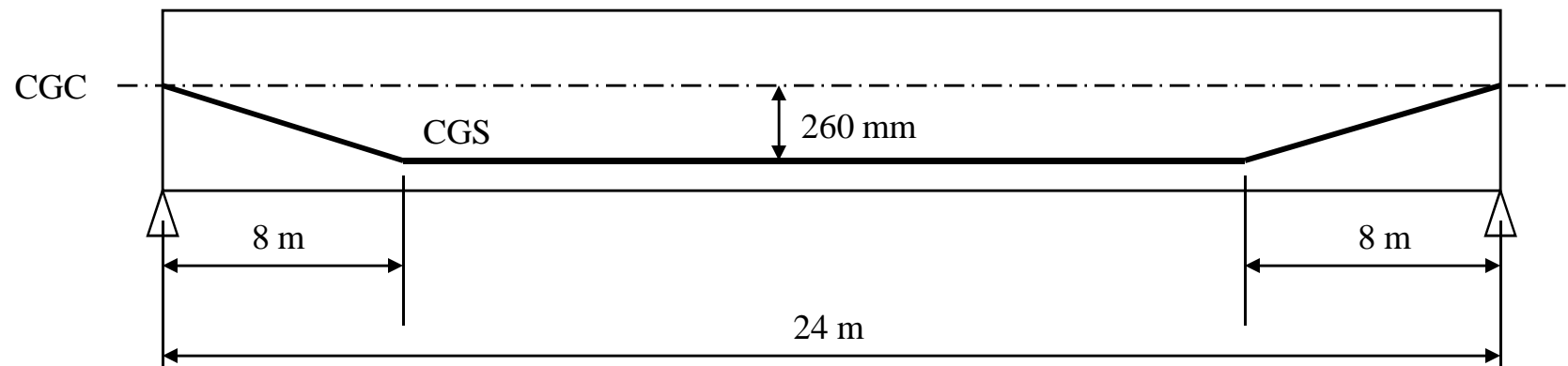

Solution

Beam self weight = 11.26 kN/m

Total service load = 11.26 + 30
= 41.26 kN/m

At Transfer, deflection(camber), due to prestress force

$$\begin{aligned}\delta &= -6800 \times 24^2 [0.26 - 4 \times 0.26 \times 8^2 / (3 \times 24^2)] / (8 \times 28 \times 10^6 \times 0.06396) \\ &= -0.0605 \text{ m } \uparrow\end{aligned}$$

At Transfer, deflection due to vertical load,

$$\begin{aligned}\delta &= 5 \times 11.26 \times 24^4 / (384 \times 28 \times 10^6 \times 0.06396) \\ &= 0.0272 \text{ m } \downarrow\end{aligned}$$

$$\delta_{st} = -0.0605 + 0.0272 = -0.0333 \text{ m } \uparrow < \text{span}/250 = 0.096\text{m}$$

Solution

At Service, deflection(camber), due to prestress force

$$\begin{aligned}\delta &= -4500 \times 24^2 [0.26 - 4 \times 0.26 \times 8^2 / (3 \times 24^2)] / (8 \times 28 \times 10^6 \times 0.06396) \\ &= -0.0401 \text{ m} \uparrow\end{aligned}$$

At Service, deflection due to vertical load,

$$\begin{aligned}\delta &= 5 \times 41.26 \times 24^4 / (384 \times 28 \times 10^6 \times 0.06396) \\ &= 0.0995 \text{ m} \downarrow\end{aligned}$$

$$\delta_{st} = -0.0401 + 0.0995 = 0.0594 \text{ m} \downarrow < \text{span}/250 = 0.096 \text{ m}$$

Long-term Deflection

- Effect of shrinkage usually small and are often ignored
- Effect of creep may be estimated using a method given in BS8110 whereby an effective modulus of elasticity, $E_{c \text{ eff}}$ is given by

- $E_{c \text{ eff}} = E_{c,t} / (1 + \phi) \dots \dots \dots (24)$

- $E_{c,t} = E_{c,28} [0.4 + 0.6 \times f_{cu,t} / f_{cu,28}] \dots \dots \dots (25)$

- $E_{c,28} = 20 + 0.2 f_{cu,28} \dots \dots \dots (26)$

- Total long term deflection = $\delta_{lt,pl} + \delta_{st,tl} - \delta_{st,pl}$

Use tables
from
BS8110:Part2

- Where,

$\delta_{lt,pl}$ – long-term deflection under the permanent load

$\delta_{st,tl}$ – short-term deflection under the total load (service)

$\delta_{st,pl}$ – short-term deflection under the permanent load

Example 4-2

Determine the long-term deflection of the beam in Example 14, if two-thirds of the total service load is permanent. Assume $f_{cu,28} = 40 \text{ N/mm}^2$; $b = 930\text{mm}$; $h = 1035\text{mm}$; $A = 47.82 \times 10^4\text{mm}^2$

Solution:

long-term (> 1 year) $f_{cu,\infty} = 50 \text{ N/mm}^2$; $E_{c,28} = 28 \text{ kN/mm}^2$

$$E_{c,\infty} = E_{c,28} [0.4 + 0.6 \times f_{cu,\infty} / f_{cu,28}] = 28[0.4 + 0.6 \times 50/40]$$

$$= 32.2 \text{ kN/mm}^2$$

$$t_{\text{eff}} = 2 \times 47.82 \times 10^4 / [2(930+1035)] = 243.4 \text{ mm}$$

For out door exposure, $\phi = 0.9$

$$E_{c \text{ eff}} = 32.2 / (1 + 0.9) = 16.9 \text{ kN/mm}^2$$

the effective section thickness is defined, as twice the cross-sectional area divided by the exposed perimeter.

Solution

Short-term deflection under permanent load

Due to prestress force:

$$\begin{aligned}\delta &= -4500 \times 24^2 [0.26 - 4 \times 0.26 \times 8^2 / (3 \times 24^2)] / (8 \times 28 \times 10^6 \times 0.06396) \\ &= -0.0401 \text{ m} \uparrow\end{aligned}$$

Due to vertical load (Service Load*2/3):

$$\begin{aligned}\delta &= 5 \times (2/3) \times 41.26 \times 24^4 / (384 \times 28 \times 10^6 \times 0.06396) \\ &= 0.0664 \text{ m} \downarrow\end{aligned}$$

$$\delta_{st,pl} = -0.0401 + 0.0664 = 0.0263 \text{ m} \downarrow$$

Solution

Short-term deflection under full service load

Due to prestress force:

$$\begin{aligned}\delta &= -4500 \times 24^2 [0.26 - 4 \times 0.26 \times 8^2 / (3 \times 24^2)] / (8 \times 28 \times 10^6 \times 0.06396) \\ &= -0.0401 \text{ m} \uparrow\end{aligned}$$

Due to vertical load:

$$\begin{aligned}\delta &= 5 \times 41.26 \times 24^4 / (384 \times 28 \times 10^6 \times 0.06396) \\ &= 0.0995 \text{ m} \downarrow\end{aligned}$$

$$\delta_{st,tl} = -0.0401 + 0.0995 = 0.0595 \text{ m} \downarrow$$

Solution

Long-term deflection under permanent load

Due to prestress force:

$$\begin{aligned}\delta &= -4500 \times 24^2 [0.26 - 4 \times 0.26 \times 8^2 / (3 \times 24^2)] / (8 \times 16.9 \times 10^6 \times 0.06396) \\ &= -0.0663 \text{ m} \uparrow\end{aligned}$$

To be exact, PL = Gk + x%Qk

Due to vertical load (Service Load*2/3):

$$\begin{aligned}\delta &= 5 \times (2/3) \times 41.26 \times 244 / (384 \times 16.9 \times 10^6 \times 0.06396) \\ &= 0.1100 \text{ m} \downarrow\end{aligned}$$

$$\delta_{lt,pl} = -0.0663 + 0.1100 = 0.0437 \text{ m} \downarrow$$

The total long-term deflection = 0.0437+0.0595-0.0263=0.0769 m ↓
 < span/250 = 0.096m