

SEB4233

Biomedical Signal Processing

ECG Analysis 2: QT Dispersion Algorithm as a Predictor of Sudden Cardiac Death

Dr. Malarvili Balakrishnan



Myocardial Ischemia and Infarction

- If a coronary artery is occluded, the transport of oxygen to the cardiac muscle is decreased, causing an oxygen debt in the muscle, which is called ischemia.
- Ischemia causes changes in the resting potential and in the repolarization of the muscle cells, which is seen as changes in the T-wave.
- If the oxygen transport is terminated in a certain area, the heart muscle dies in that region. This is called an infarction (Jaakko Malmivvo and Robert Plonsey, 1995). In another word, it is known as heart attack. An infarct area is electrically silent since it has lost its excitability (Jaakko Malmivvo and Robert Plonsey, 1995).

QT Dispersion (QTd)

- QTd calculated from the 12-lead ECG has emerged as a noninvasive measurement for quantifying the degree of myocardial repolarization inhomogeneity (Day CP, et al., 1990).
- The QTd phenomenon lies in the fact that by electrodynamic laws the ventricle complex duration must be uniform for almost all leads except for special cases. But electrocardiographic measurements towards 12 lead ECG shows the lead-to-lead QT-duration distribution exists and it is used as a predictor of the heart rhythm disturbances.
- QTd used as informative index to predict sudden death. QT dispersion defined as the difference between the maximum and minimum QT intervals on any of 12 leads, it is a marker of myocardial electrical instability (Mirvis DM, 1985).
- As the increased QTd is associated with sudden death, QTd is often used as a marker of sudden arrhythmic death caused myocardial infarction.

QT Dispersion (QTd)...(cont)

- The QT interval begins at the onset of the QRS complex and terminates at the end of the T wave. It represents the time of ventricular depolarization and repolarization. It is useful as a measure of repolarization and is influenced by electrolyte balance, drugs, and ischemia. The QT interval is inversely related to heart rate. (Day CP et al., 1990).
- Location :Extends from the beginning of QRS complex to the end of the T wave.(includes the QRS complex, S-T segment and the T wave)
- Duration :Varies according to age, sex and heart rate.
Normal (0.35s-0.44s) (MD Sulaiman et al., 1997).

QT Dispersion (QTd)...(cont)

- $QTd = QT(\max) - QT(\min)$ (Day CP et al., 1990).
- If the QT dispersion value was > 60 ms (MD Sulaiman et al., 1997), there would be a higher risk of sudden death.

Research Methodology

Below is the block diagram of the whole system.

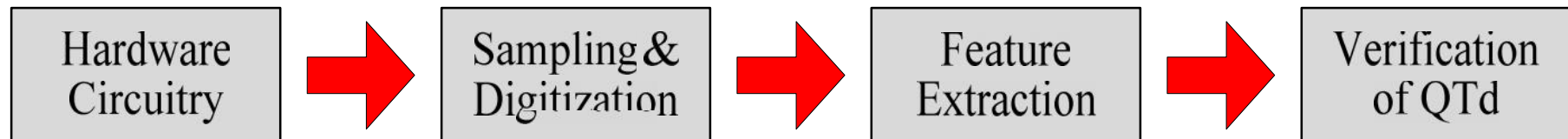

Hardware circuitry

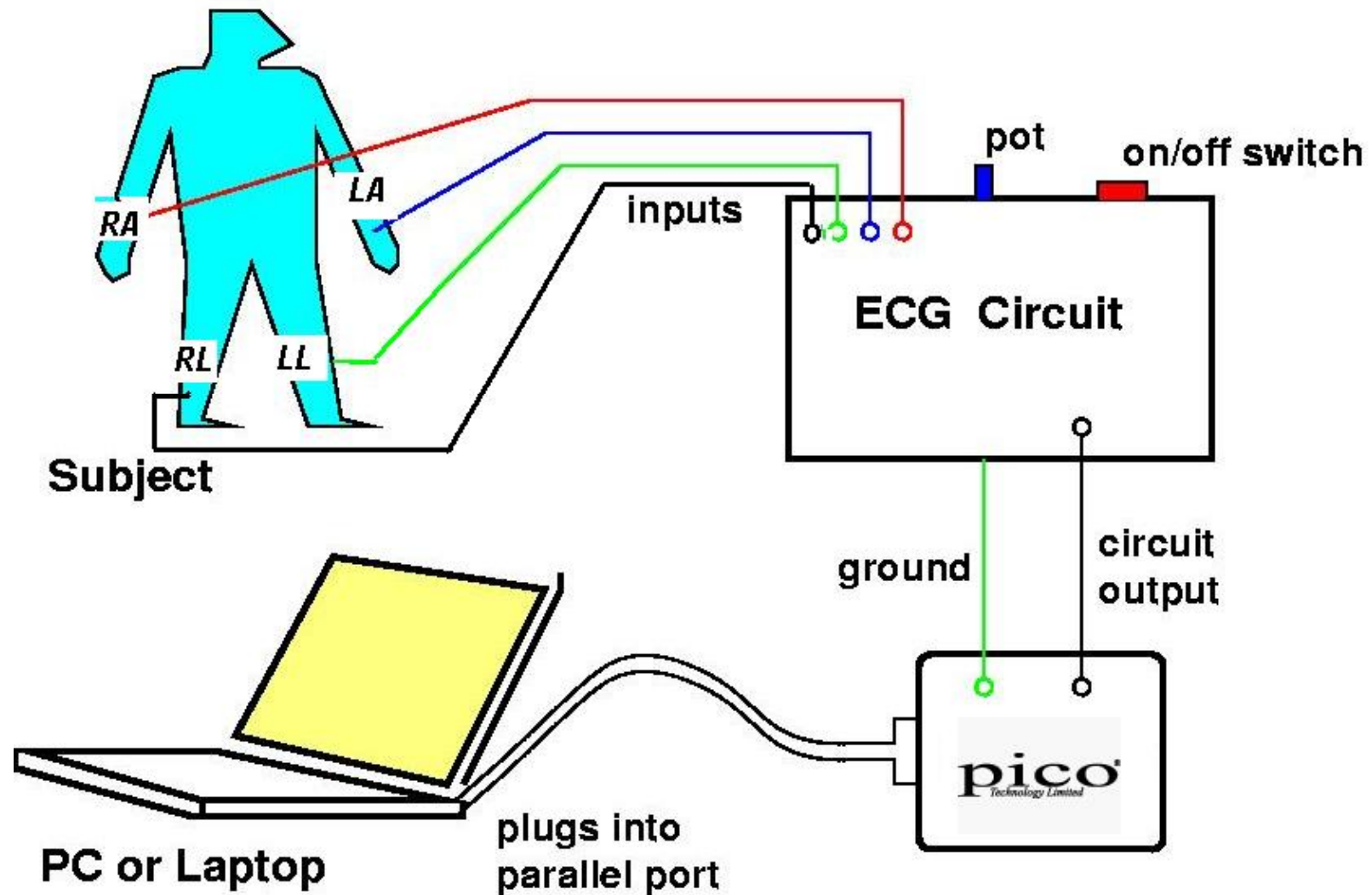

Hardware circuitry...(cont)

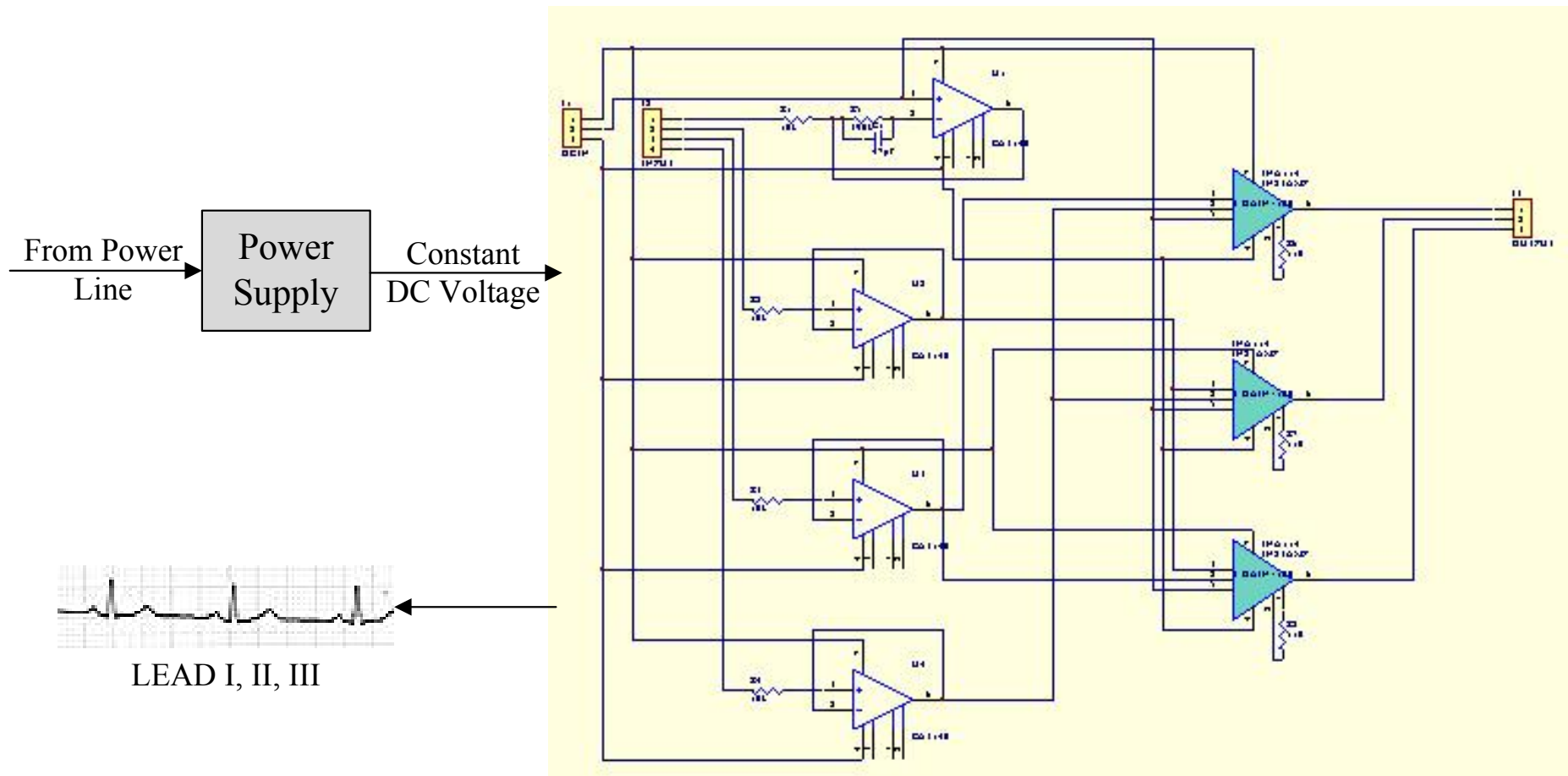

3 LEAD ECG CIRCUIT

ECG Circuit

- Instrumentation amplifier is used to amplify low-level signals in the presence of high common-mode noise. It is used for its high accuracy, precise gain and very high common mode rejection ratio (CMRR). (Buchla et al, 1992).
- There are 3 basic inputs for this circuit which are RA, LA and LL. These inputs are the bipolar leads. The buffer amplifier stage is to prevent electrode-offset voltage from saturating the amplifiers.
- The common-mode signal will be inverted into the right leg drive (RL). It is used to reduce the 50 Hz power line noise.

Data Acquisition

- The standard 12 lead ECG were recorded simultaneously for each patient from the age group of 60 .[±]There were 53 patients eligible for the data collection process. ECG data were gathered from 2 clinical groups which consist of 28 normal patients (15 female and 13 male) and 25(13 female and 12 male) patients with Myocardial Infarction (MI).
- Data were obtained from patients from Hospital Universiti Kebangsaan Malaysia (HUKM).
- A PC with PC-ECG interface card is used as data acquisition equipped with a 12 bit analogue to digital conversion card. The ECG was digitized at sampling frequency of 500Hz. The signals were recorded for 8 leads (V1, V2, V3, V4, V5, V6, I, II).

Software Development

- This involves the development of QT dispersion algorithm which consists of the following process.
- The algorithm discussed below are for one lead but the same approach is done to 8 lead of ECG to determine the QT dispersion.

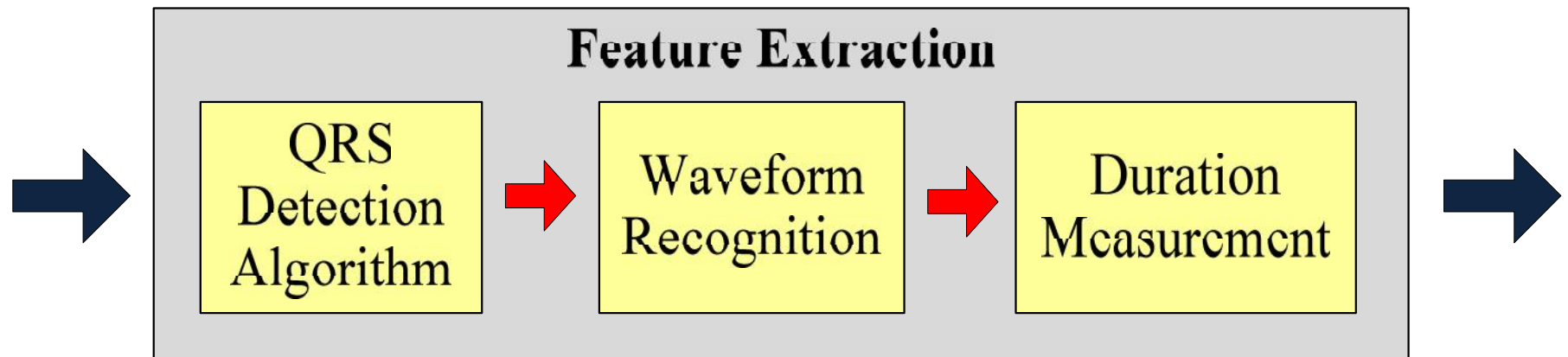

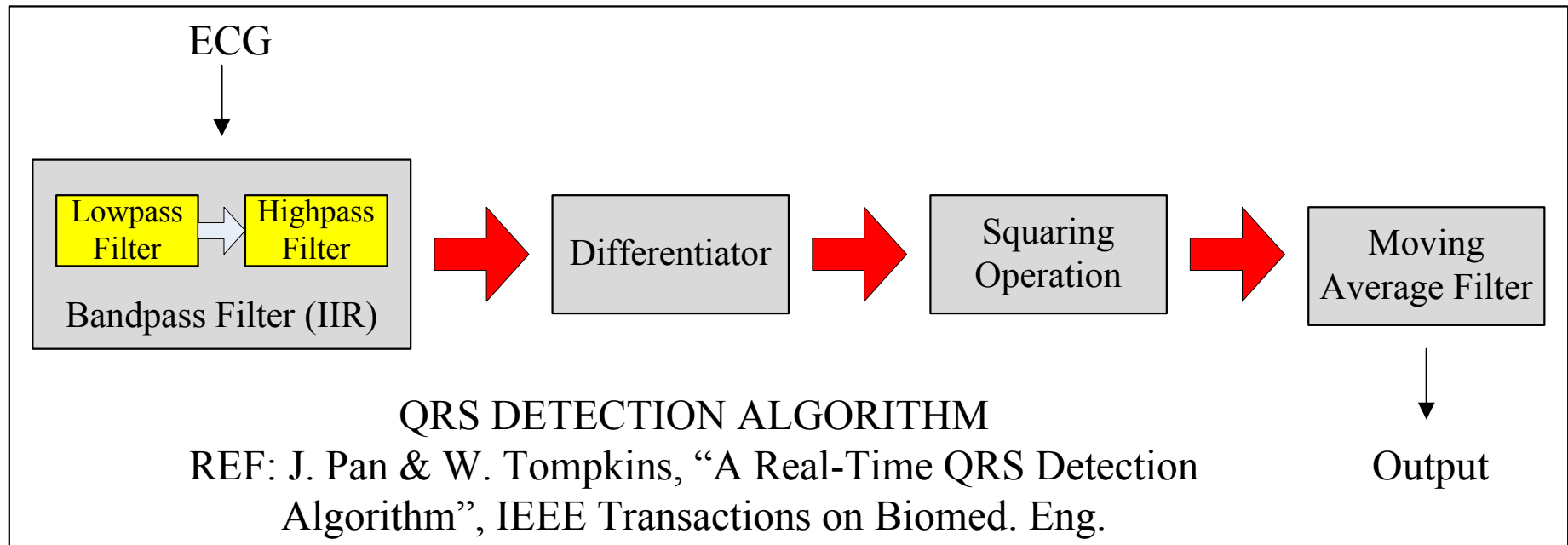
**Waveform Recognition**

-P, Q, R, S, T wave

Duration Measurement

-Heart Rate
- QT Dispersion

Methodology

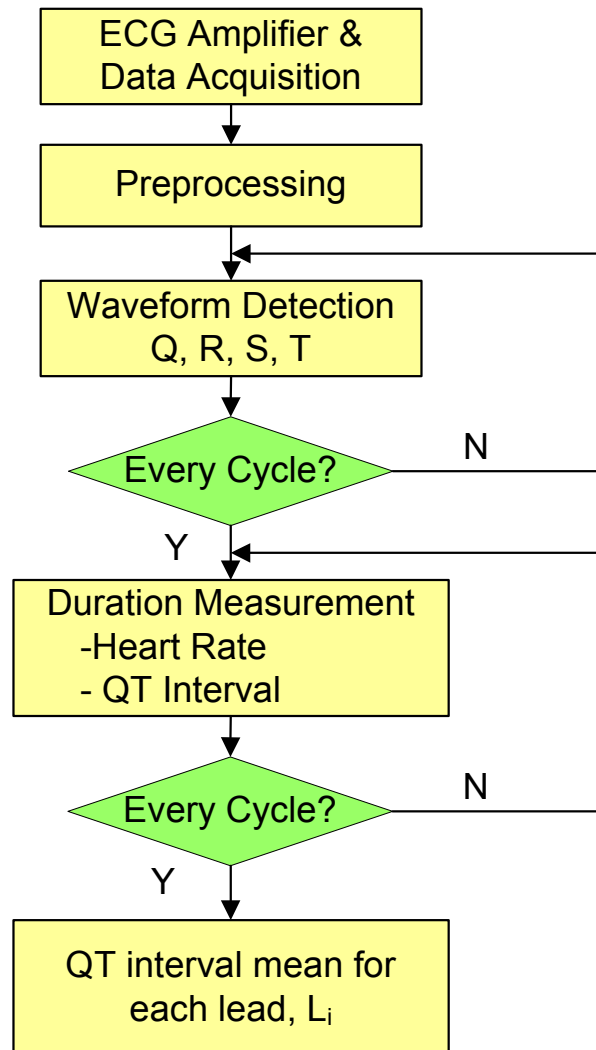

Figure: Flow Chart of the Algorithm to Compute QT Interval for Every Cycle in a Lead

Waveform Recognition

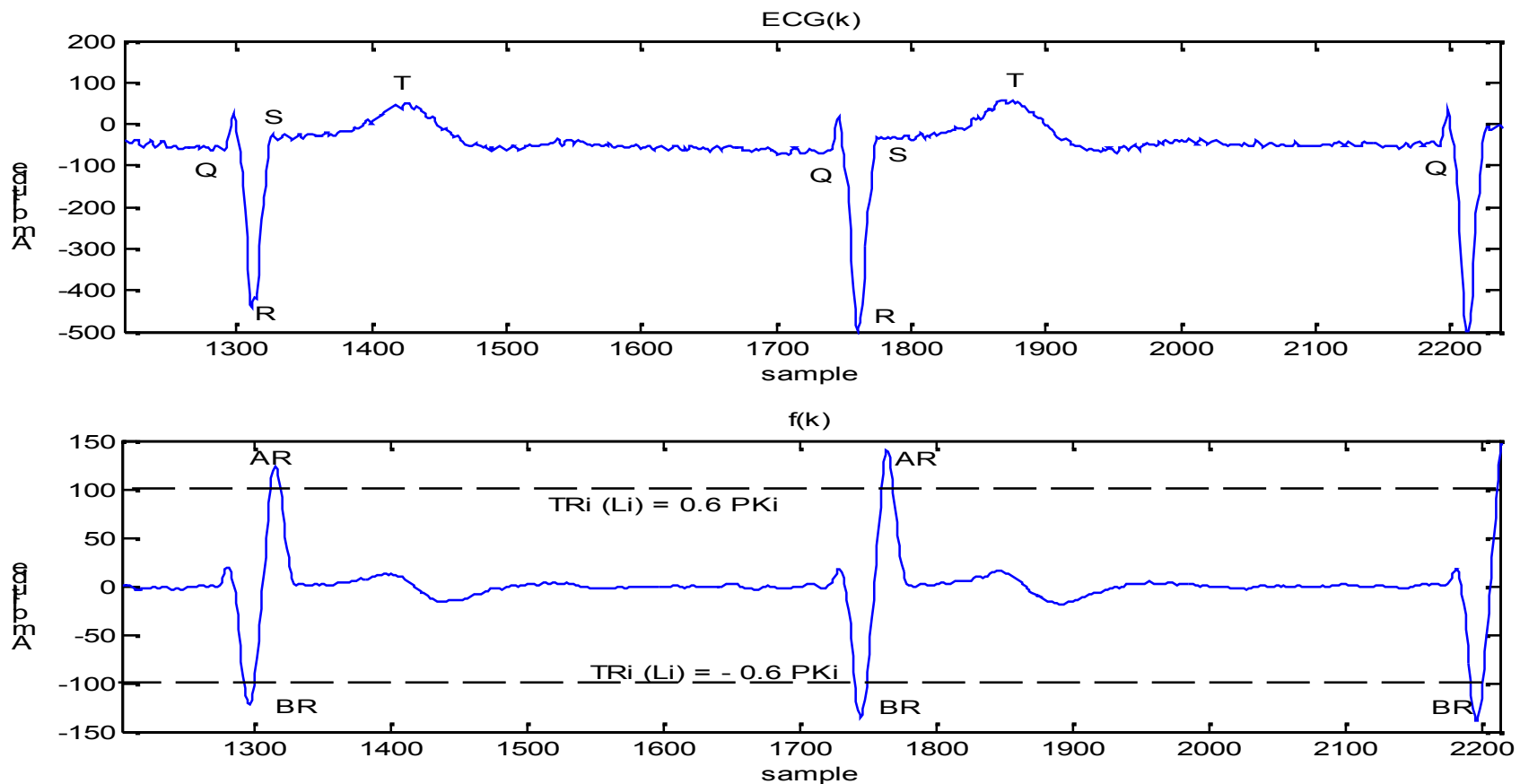
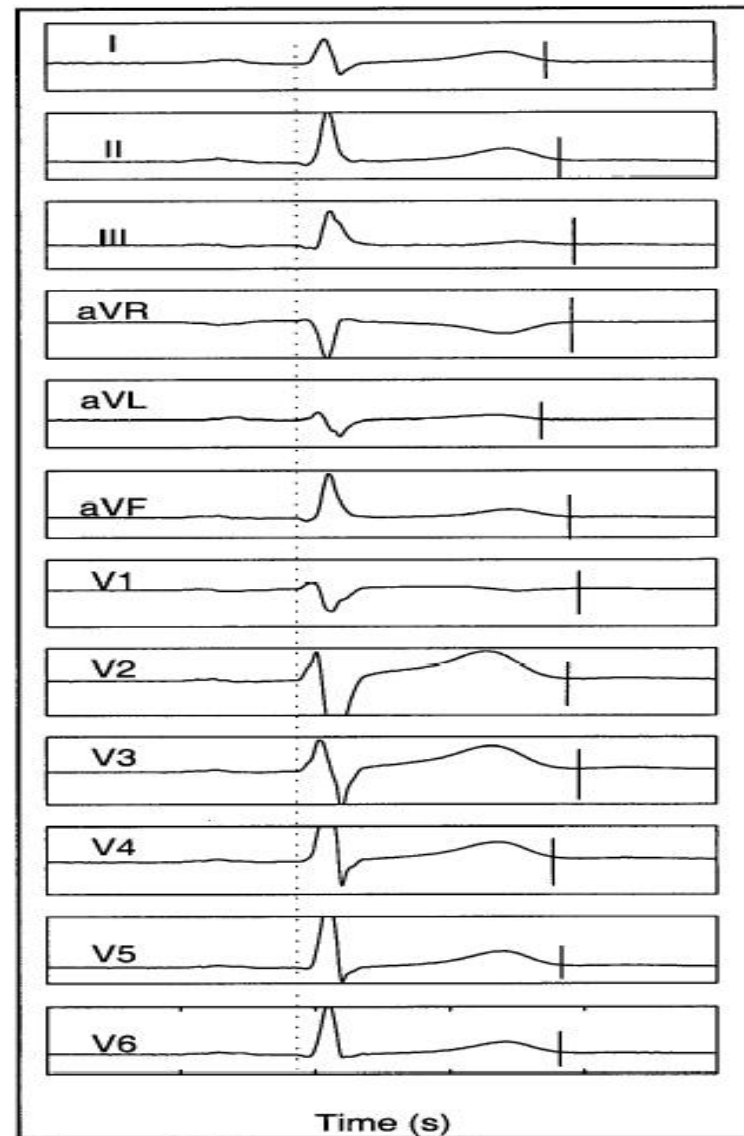

Figure: Figure shows the AR peak and BR peak location detection with respective threshold

T end Detection

Figure: Various shapes of T wave in Standard 12 lead ECG.



T wave

Normal T wave (upward-downward)

- The location of AT peak (max) and BT peak (min) of a cardiac cycle within the window defined are compared. If the AT peak location occurs first before the BT peak location, the condition of $|max| > 4|min|$ is checked. If it is false, the T wave is considered normal T wave (upward-downward).

Only upward T wave

- The location of AT peak (max) and BT peak (min) of a cardiac cycle within the window defined are compared. If the AT peak location occurs first before the BT peak location, the condition of $|max| > 4|min|$ is checked. In this case, if it is true, the T wave is considered as only upward.

Inverted T wave (downward-upward)

- The location of AT peak (max) and BT peak (min) of a cardiac cycle within the window defined are compared. If the BT peak location occurs first before the AT peak location, then a minimum point (mina) is searched between the max and ewind. If $|max| < 4|mina|$, again the upward-downward T wave is considered. Otherwise, then next criteria, $|min| > 4|max|$ is checked. The true case makes the T wave inverted.

Only downward T wave

- The location of AT peak (max) and BT peak (min) of a cardiac cycle within the window defined are compared. If the BT peak location occurs first before the AT peak location, then a minimum point (mina) is searched between the max and ewind. If $|max| > 4|mina|$ and $|min| < 4|max|$, it is considered as only downward T wave.

T end Detection

- T offset is defined as the intersection of the T slope which best fit between 10% and 30% of T wave amplitude with the isoelectric baseline.

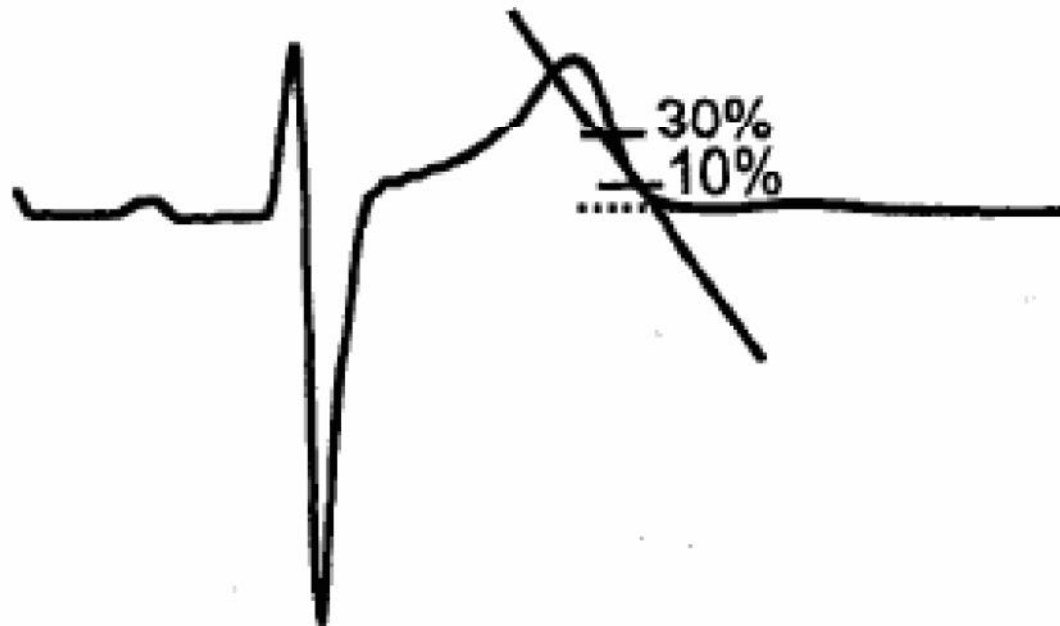

T end detection

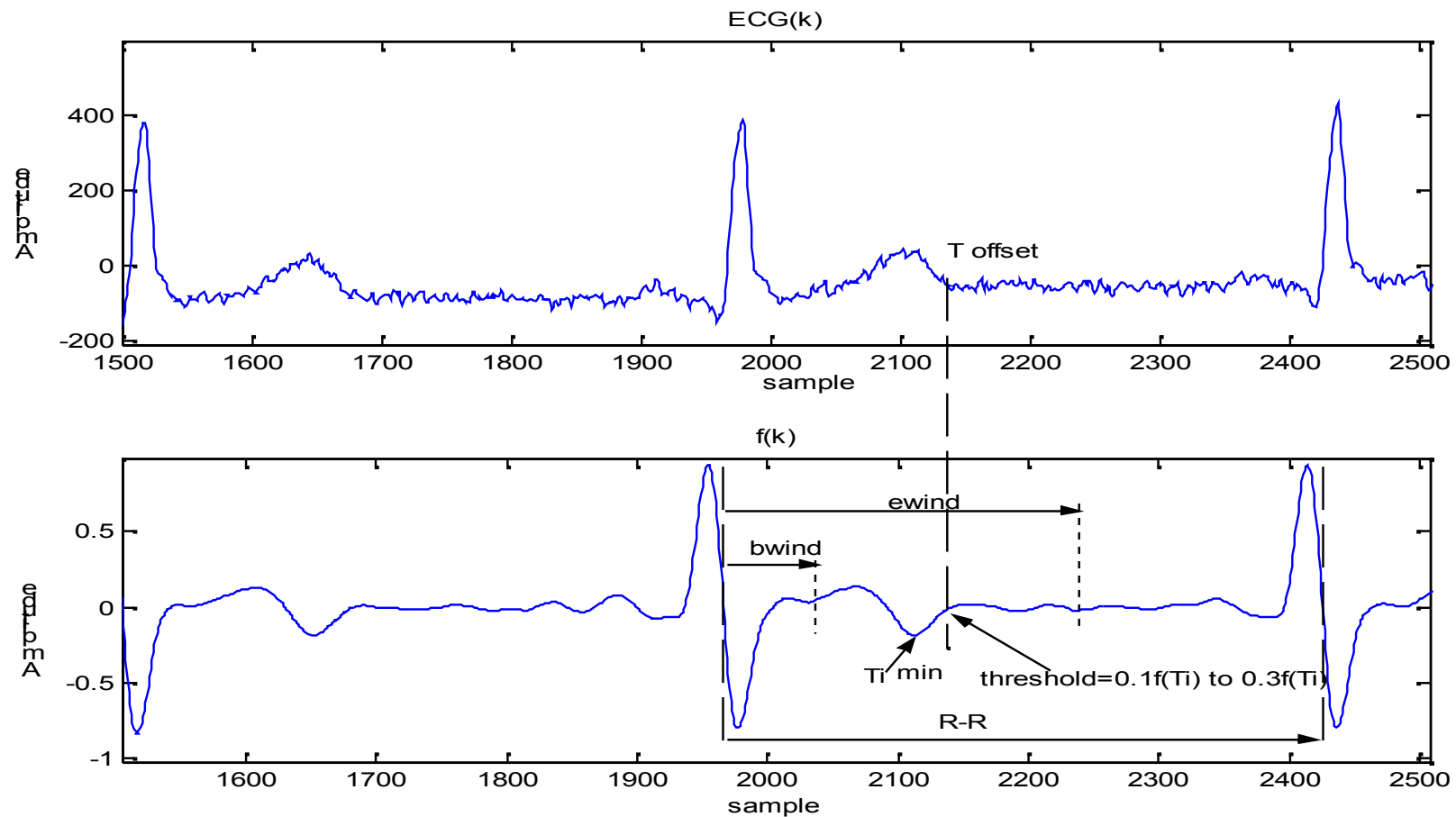
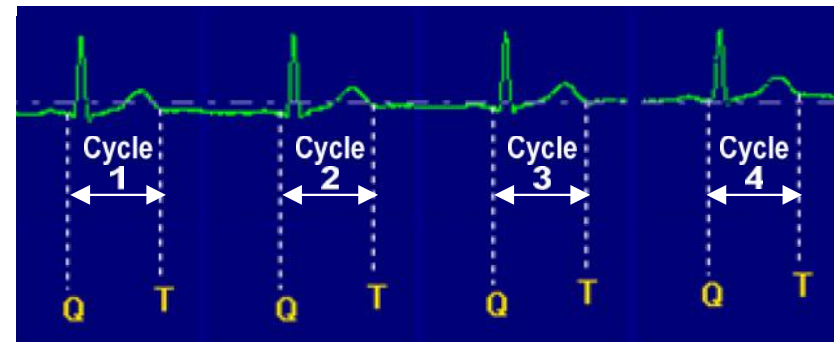
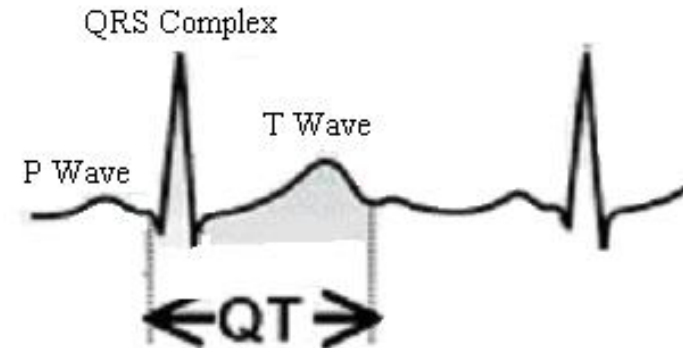

Figure: The bwind, ewind and T wave offset location detection with respective threshold.

Duration Measurement

- Heart rate = $60\,000 / \text{RR interval (ms)}$
- QT interval
- QT interval mean for a lead = $[\text{QT interval (cycle 1)} + \text{QT interval (cycle 2)} + \text{QT interval (cycle 3)} + \text{QT interval (cycle 4)}] / 4$.
- QT dispersion (QTd) is the difference between the maximum and minimum of QT intervals on any of 12 leads in ms. QTd for 8 leads, excluding the derived leads (III, aVF, aVL, aVR) is also computed in ms.



Result- 8 Lead Analysis

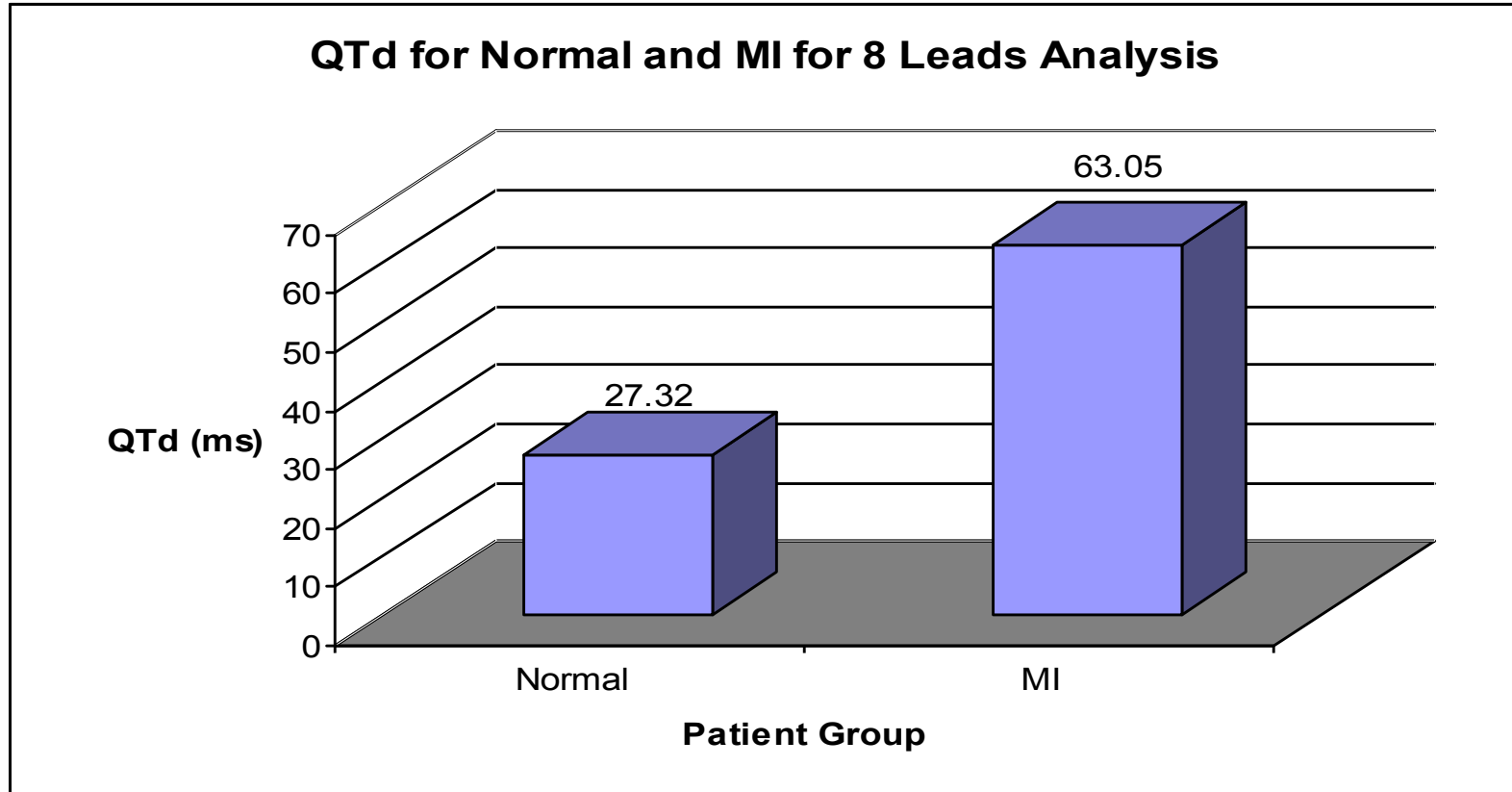

Figure : The QTd means measurement classified by patient group.

Result- 8 Lead Analysis

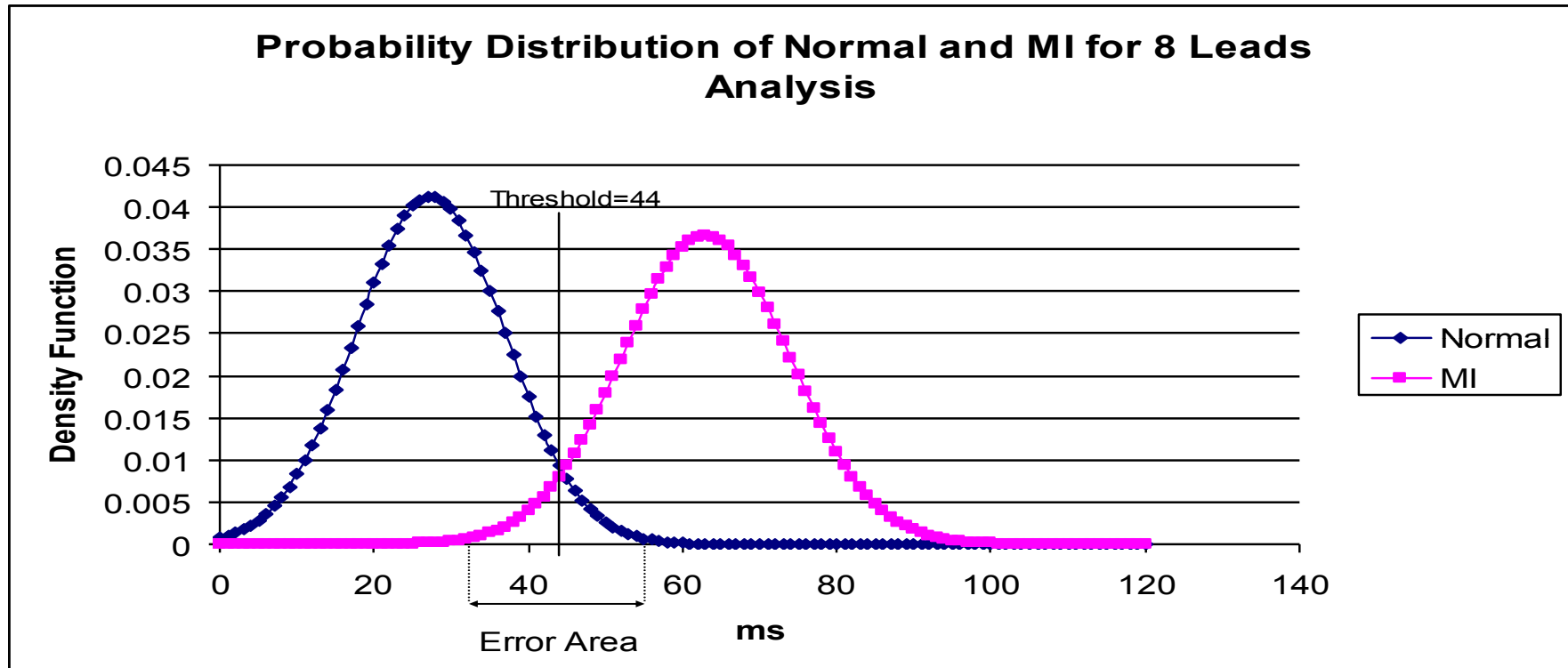

Figure : Distribution of QTd for Normal and MI.

Result- 12 Lead Analysis

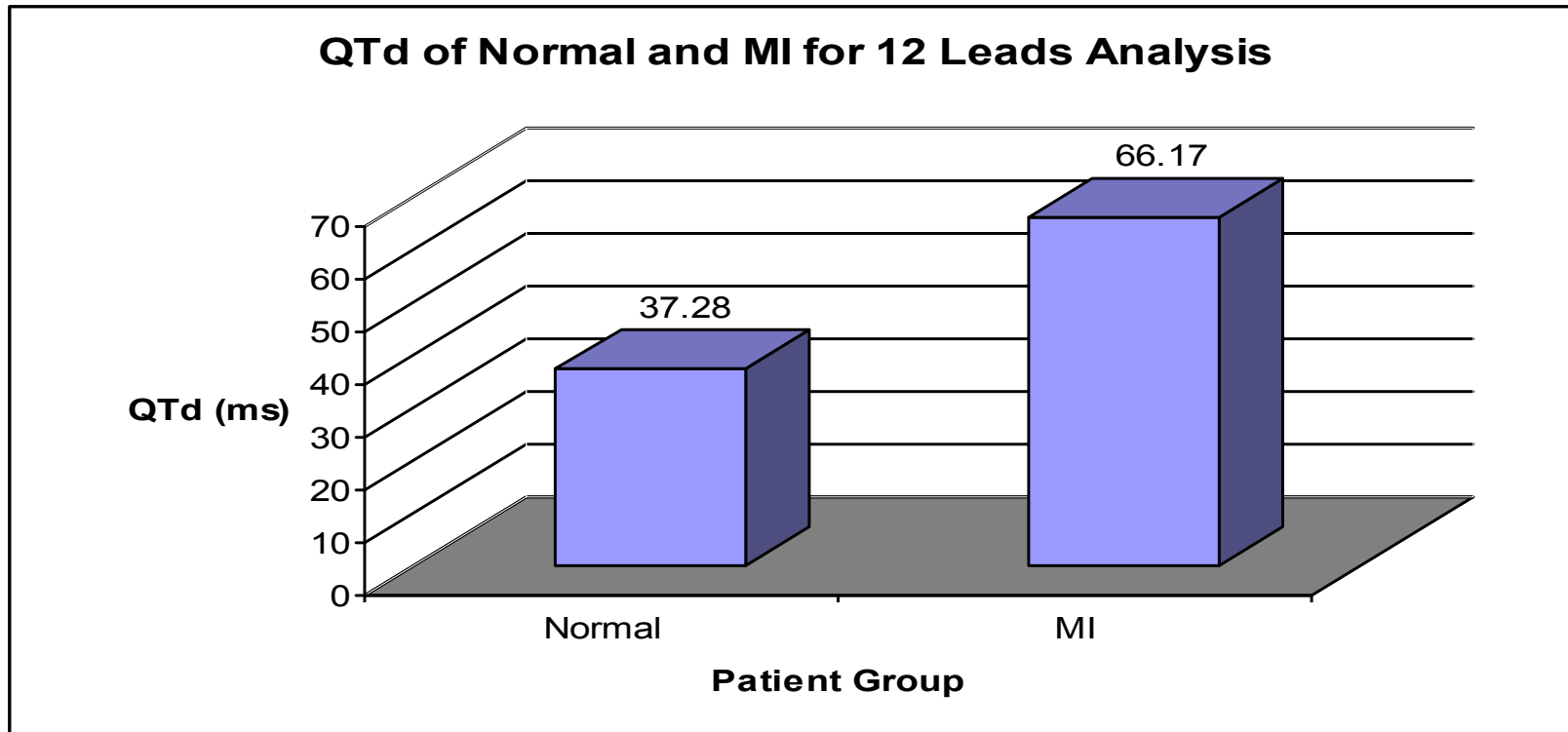

Figure : The QTd means measurement classified by patient group

Result- 12 Lead Analysis

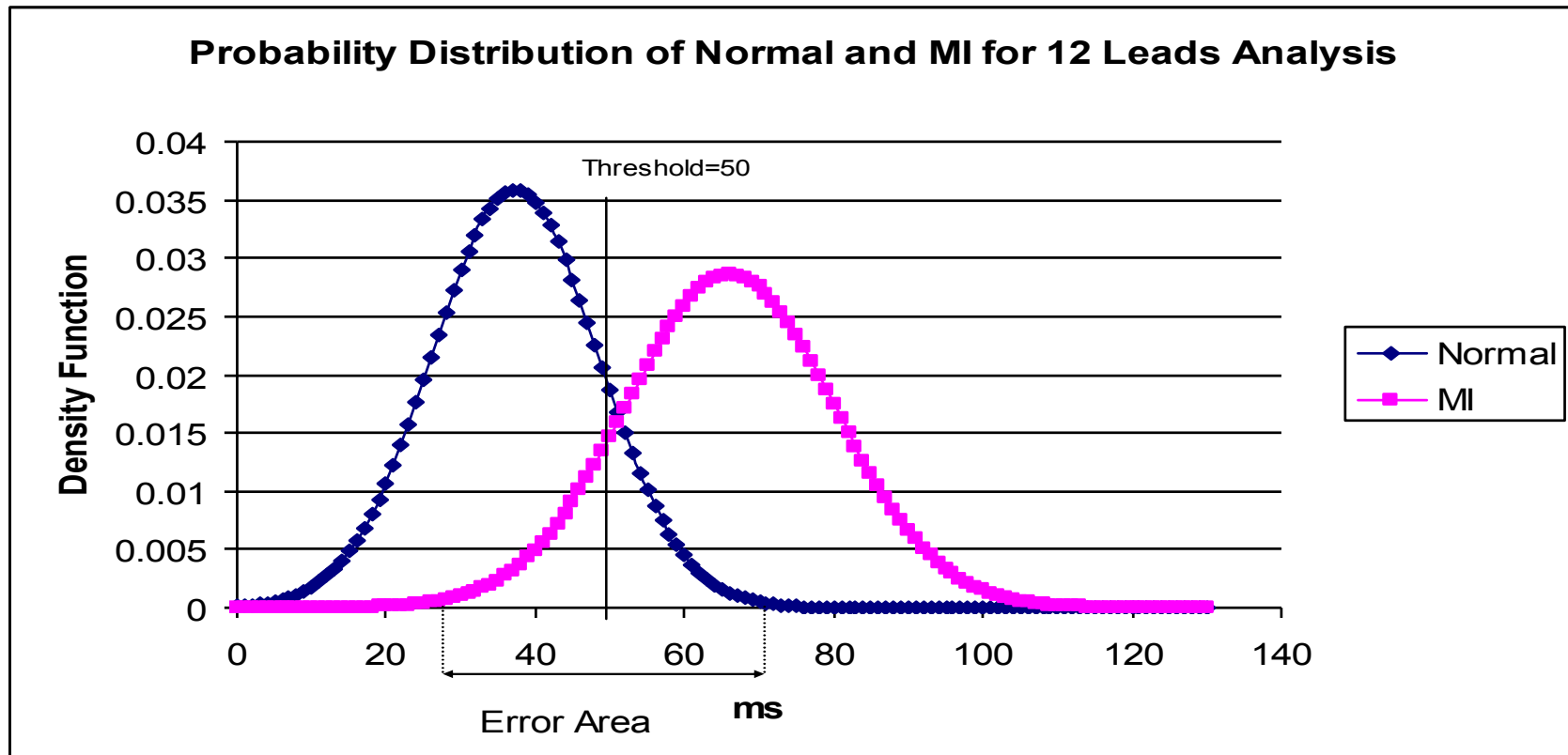
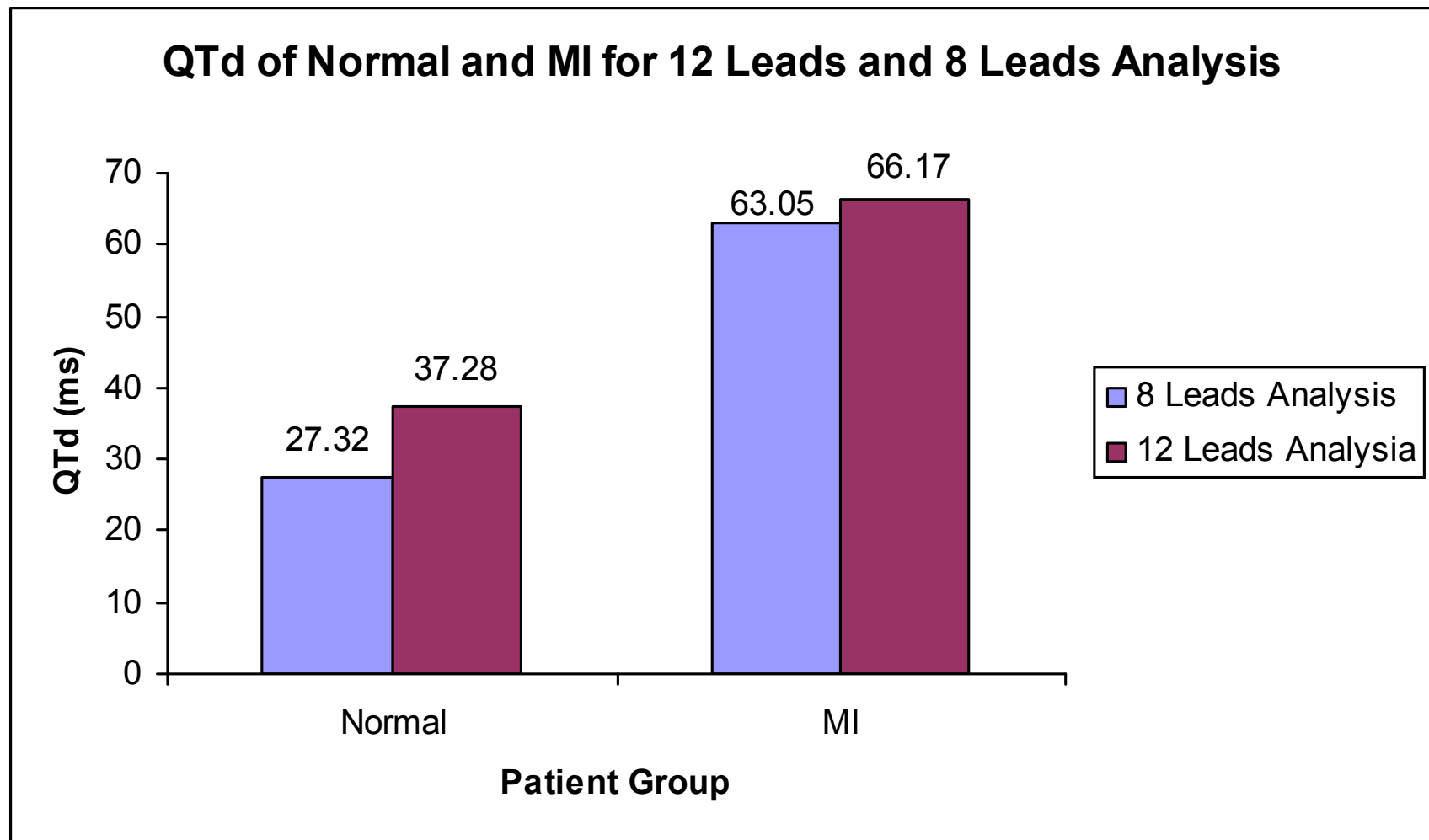
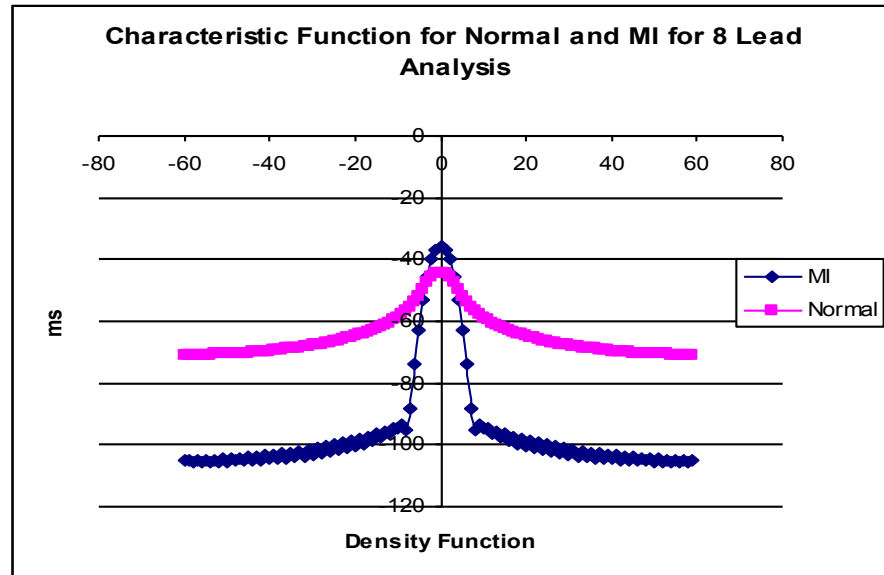

Figure : Distribution of QTd for Normal and MI

Conclusion



Conclusion



Characteristic Function of Normal and MI for 8 lead Analysis.

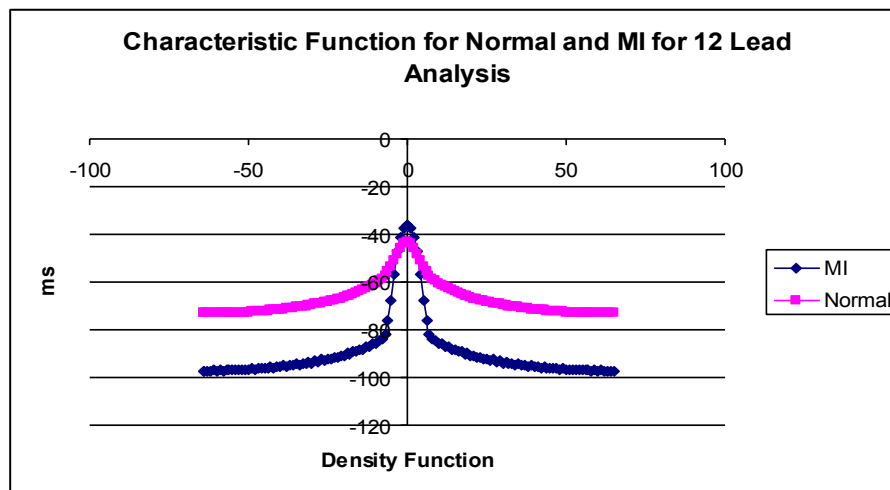

Characteristic Function of Normal and MI for 12 lead Analysis.