

Materials Technology

Polymer

Dr Jasmi Hashim

INTRODUCTION

What is a Polymer?

Poly **mer**
 many repeat unit

Most polymers are hydrocarbons
 – i.e., made up of H and C

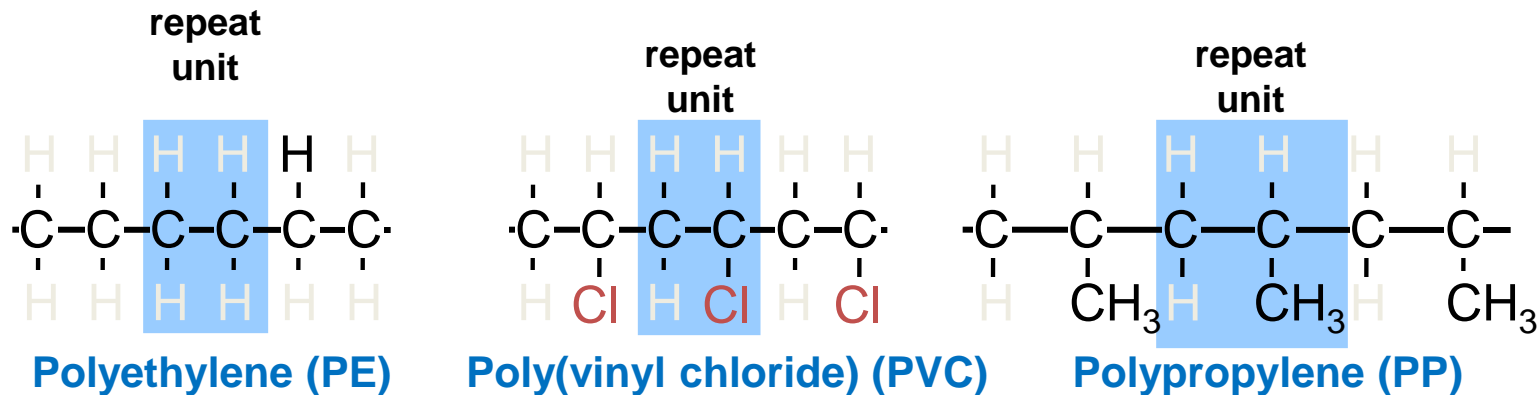

- Originally natural polymers were used
 - Wood
 - Cotton
 - Leather
 - Rubber
 - Wool
 - Silk

Polystyrene
(PS)

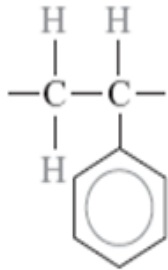

Polyhexamethylene Adipamide
(Nylon 6,6)

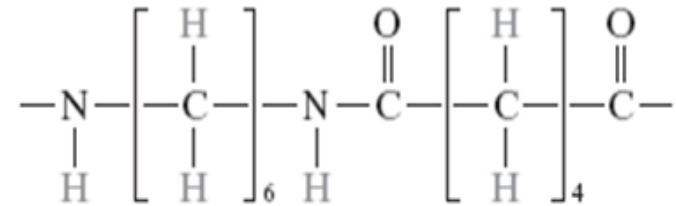

Polymethyl metracrylate
(PMMA)

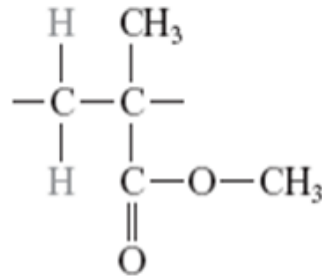

Polycarbonat
(PC)

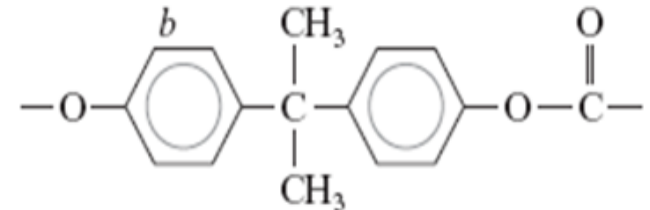

Phenol formaldehyde
(Bakelite)

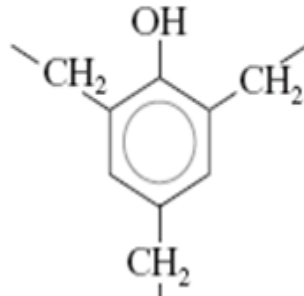

Polyethylene terephthalate
(PET, a polyester)

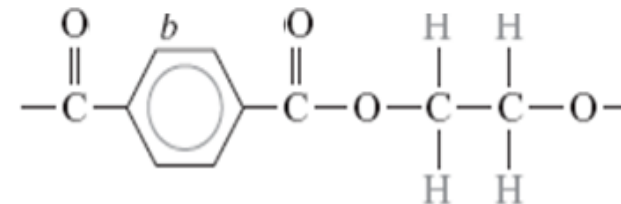

**Polymer are long chain molecules:
Wwhich are formed by polymerization
by linking, or cross-linking of the same or different monomers.**

Monomer

Basic building block of polymers.

Polymer means – many mers, generally repeated hundreds of thousands of times in a chainlike structure.

Most monomers are organic materials in which carbon atoms are joined in covalent bond – with other atom

eg : H, O, N, F, Cl, Si, and S

Simple monomer consist of atom C and H



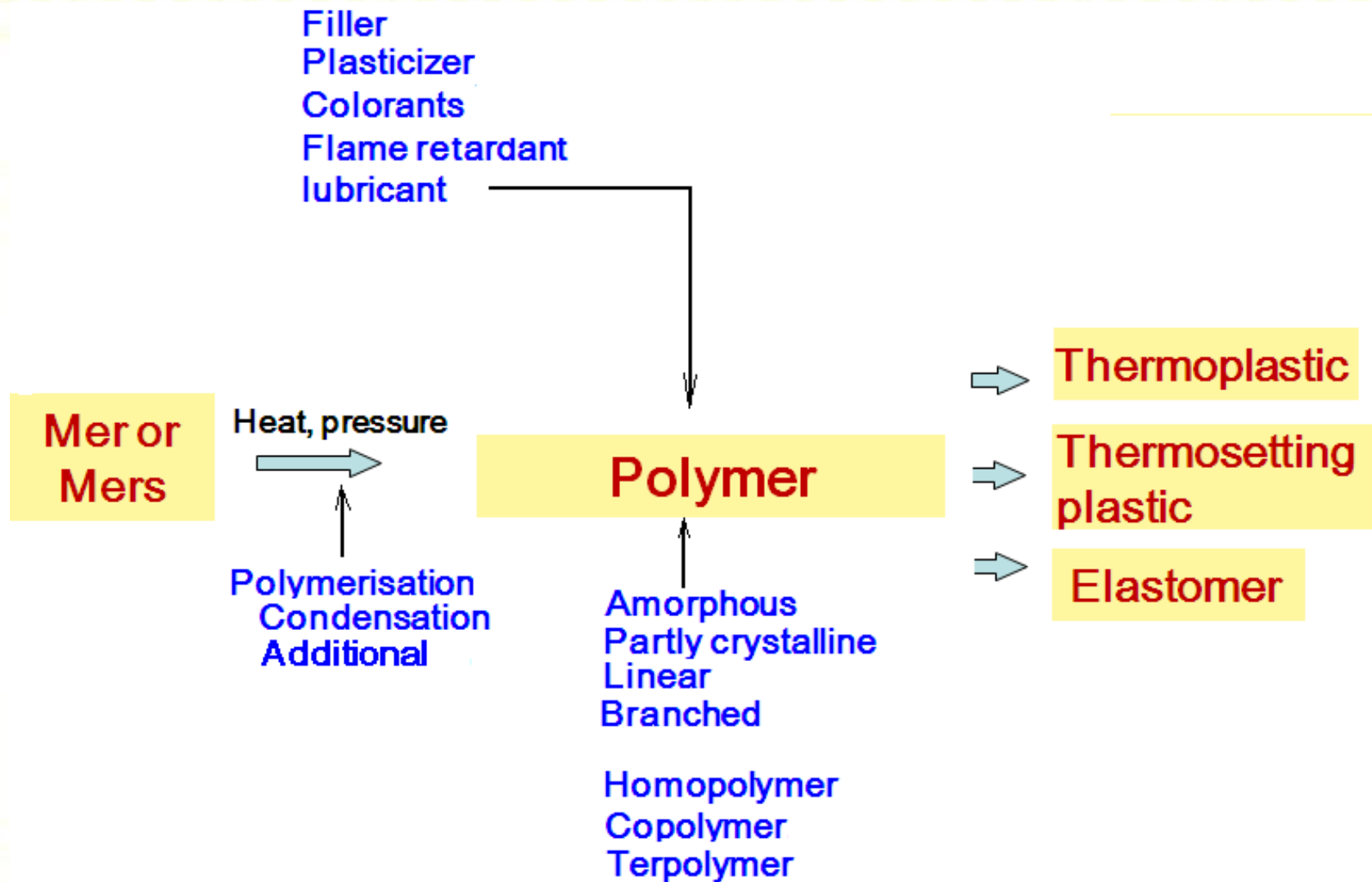

POLYMERISATION

To link monomer in polymer - repeating unit to make longer and larger molecules

- * Monomers are linked together in a covalent bond, forming a polymer chain.
- * The polymer chain are held together by a secondary bonds, such as **van der Waal bond** and **H bonds**.

Two basic polymerization processes :

- Condensation polymerization
- Addition polymerization

i. Condensation polymerization

Polymers are produced by the formation of bonds between two types of reacting mers

- also produce reaction by-product : water, acid or alcohol condensed out.

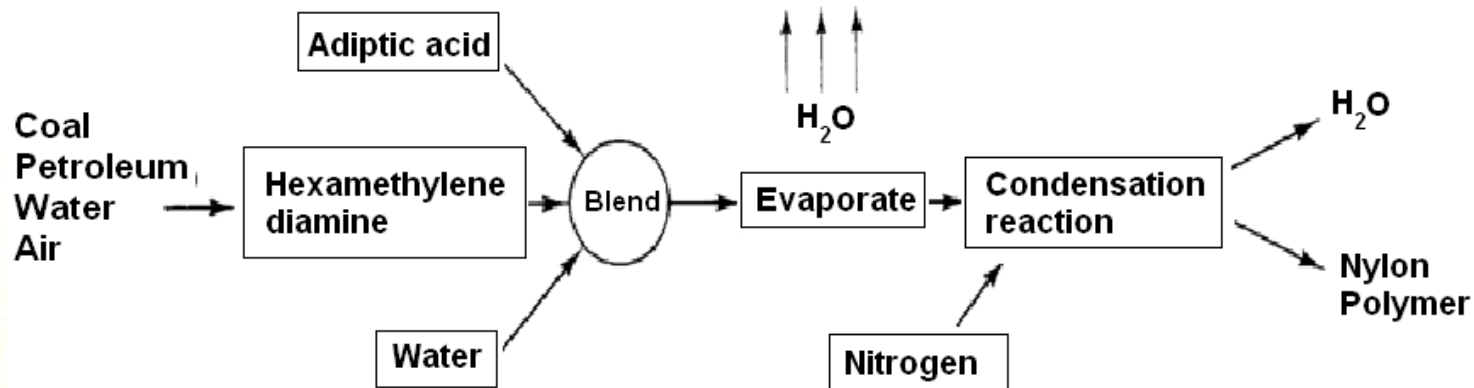

ii. Additional polymerization

Also known as chain-reaction polymerization.

Without reaction by-product

Long molecule chain form at a high rate, within a few seconds.

Initiator is added to open double bond, and begins linking process by adding more mers to a growing chain.

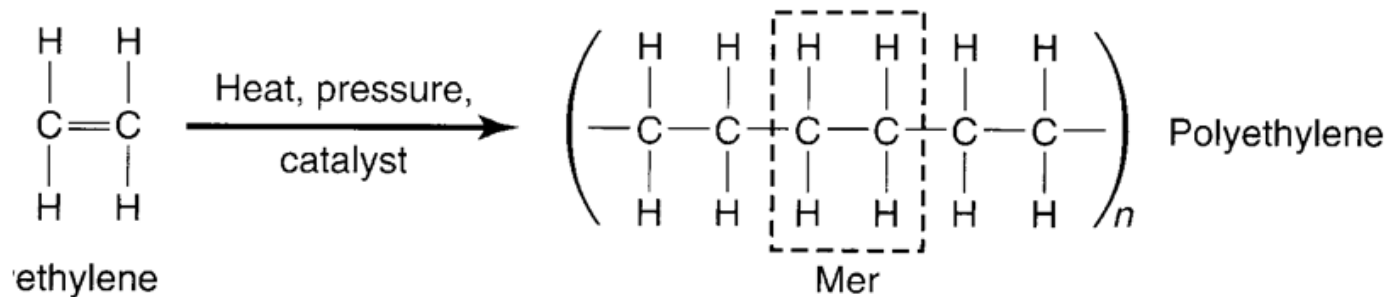

i. Initiation

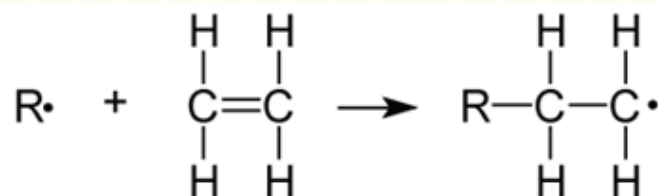

ii. Propagation

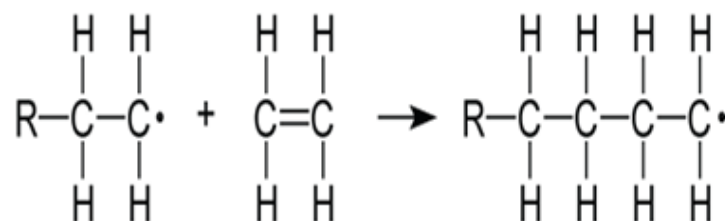

iii. Termination

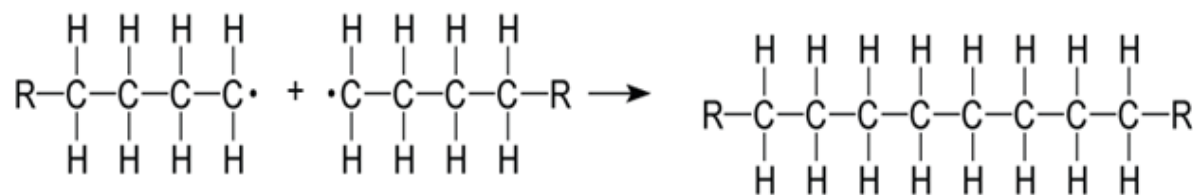

Initiator: example - benzoyl peroxide

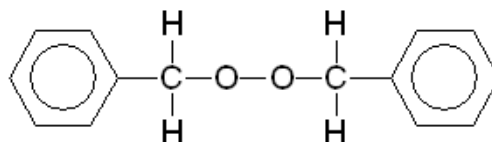

Molecular weight

The sum of molecular weight of the mers in the polymer

Molecular weight **increases**

Chain length **increase**

Molecular weight **increase**

MPs such as TS, Impact strength, resistance to cracking and viscosity

Most commercial polymer molecular weight between 10, 000 and 10 000 000

More convenient to express the size of a polymer chain in terms of degree of polymerization (DP)

$$DP : \frac{\text{Molecular weight}}{\text{Weight of monomer}}$$

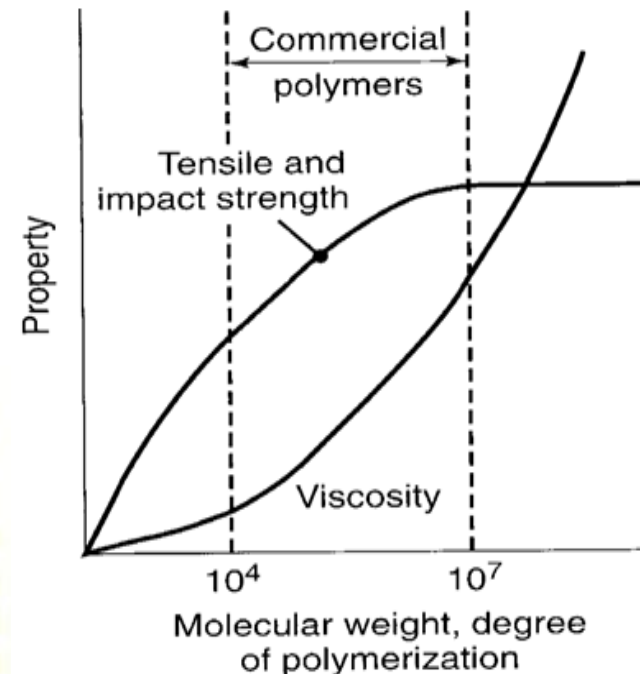

The properties of polymer depend not only on the type of **monomer**, but also on their arrangement in the **molecular structure**.

Linear polymers : - linear structure

- such as acrylics, nylon, PE, PVC
- may contain some branched cross-linked chains

Branched polymers

- Side-branch chains are attached to the main chain during polymerization.
- Branching interferes with the relative movement of the molecular chain give resistance to deformation
 - **strength increases**

Interfere with the packing efficiency of polymer chains

- **density decreases**

i. Cross-linked polymers

Have adjacent chain linked by covalent bonds
such as in vulcanized rubber

Cross-linking has major influence of MPs of polymers
imparting hardness, strength, stiffness and better
dimensional stability

Thermoplastic polymer can be cross-linked to obtain greater strength

ii. Copolymer and ter-polymers

To impart certain properties and characteristics to the polymer
(as with solid solution in metal)

Such as improving both strength and toughness, heat and chemical resistance

Two types of polymer – **Copolymer**
such as styrene-butadiene – tires

Three types of polymer – **terpolymer**

Such as ABS (Acrylonitrile-Butadiene-Styrene) , used for helmet, telephone, refrigerator liners

(contain chain are all the same type – **homopolymer**)

Crystallinity

Polymer chains exist without long-range order- **amorphous**

like worms in a bucket, a bowl of spaghetti all are intertwined with each other

It is possible to impart some **crystallinity** – to modify MPs.

During polymerisation,

- by controlling rate of solidification.
- by deformation during its subsequent processing

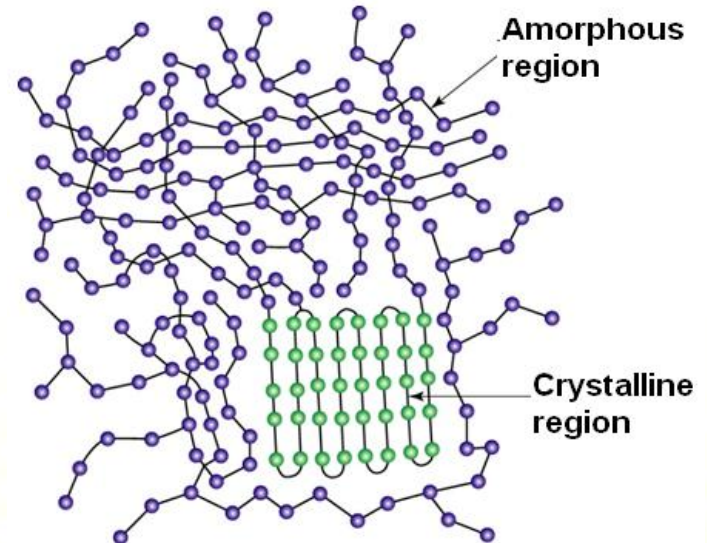

Chain Molecular Structures for Polymers

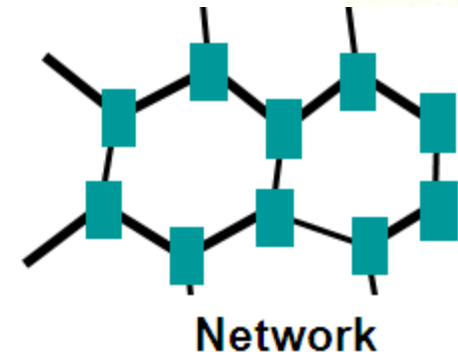
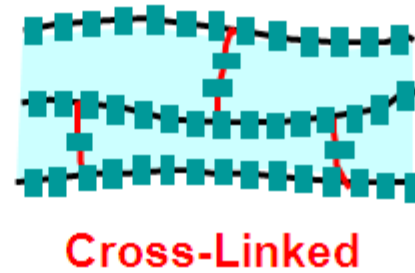
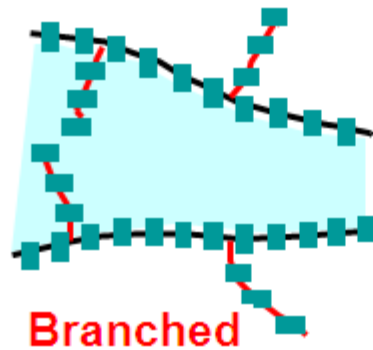
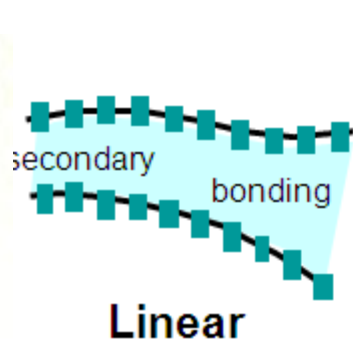

Two or more monomers polymerized together

- **Random** – A and B randomly positioned along chain
- **Alternating** – A and B alternate in polymer chain
- **Block** – large blocks of A units alternate with large blocks of B units
- **Graft** – chains of B units grafted onto A backbone

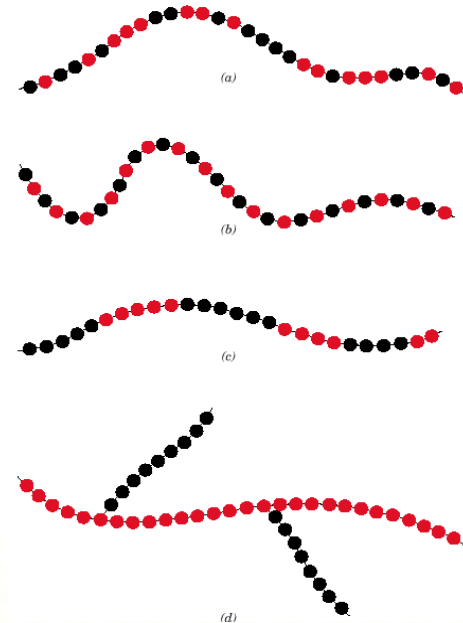

Polymers rarely 100% crystalline

- Difficult for all regions of all chains to become aligned
- Degree of crystallinity is expressed as **% crystallinity**.
 - Some physical properties depend on % crystallinity.
 - Heat treating causes crystalline regions to grow and % crystallinity to increase.

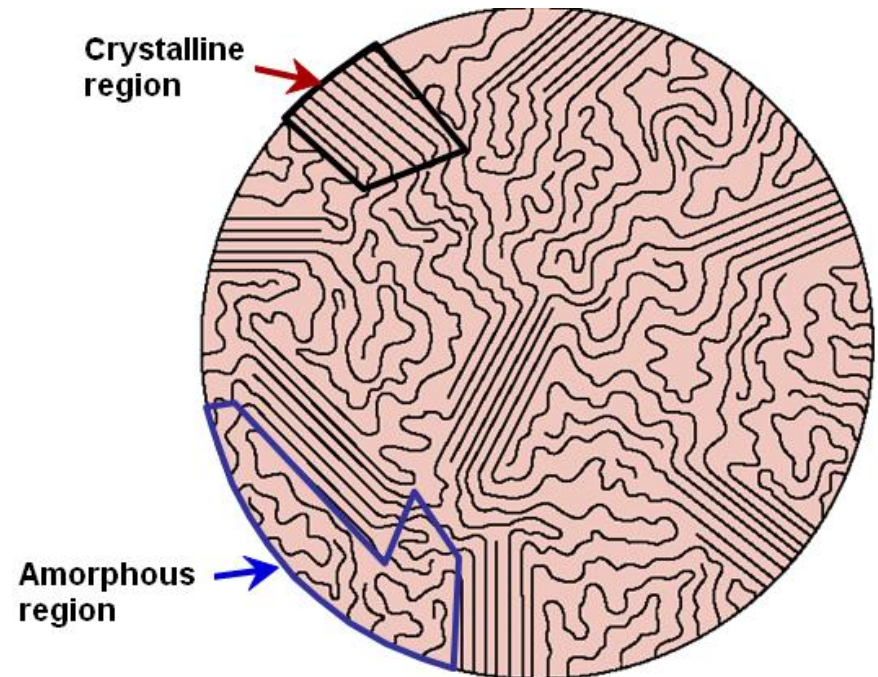

Polymer crystal : spherulite

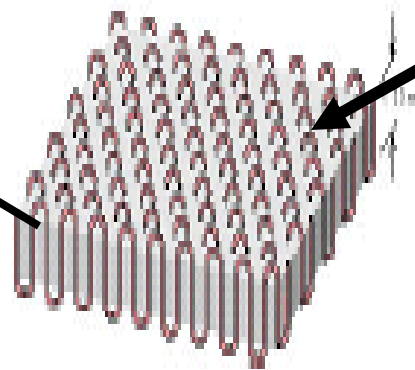
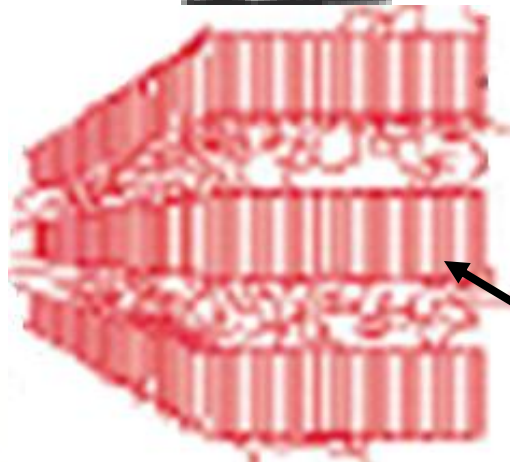
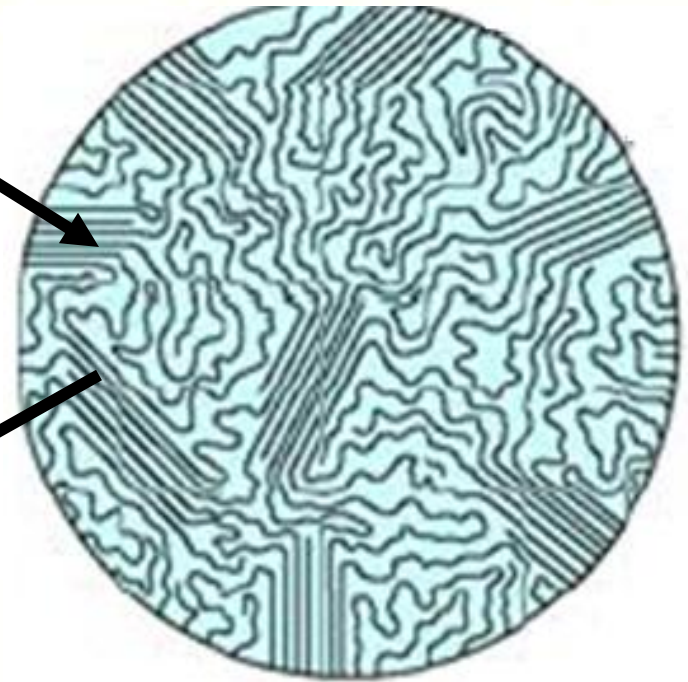
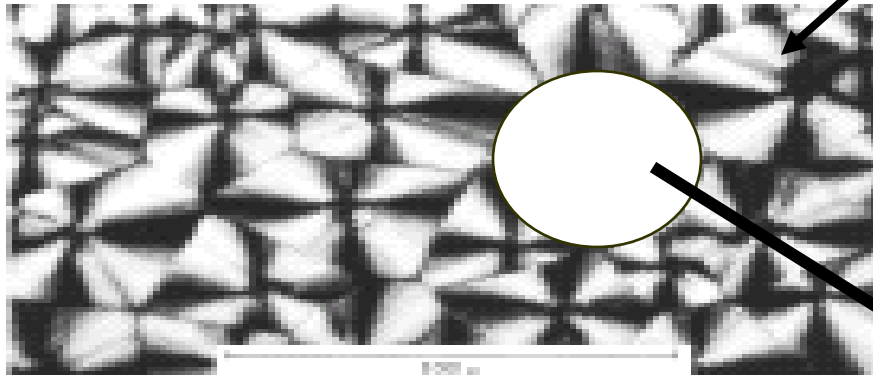

Deformation mechanism of semi-crystalline polymer

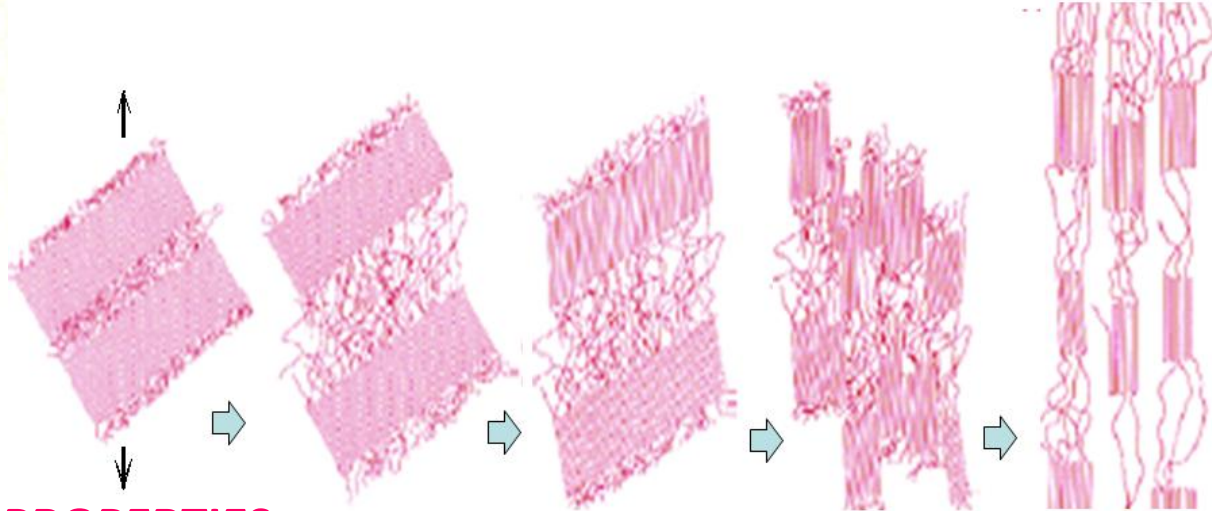

OPTICAL PROPERTIES

Refraction index is proportional to density.

The greater the density, the greater the opaqueness

Opacity increase with crystallinity

Eg : LDPE film such as sandwich bag is clear.

Eg : HDPE for detergent bottles is opaque

Completely amorphous can be transparent such as polycarbonate and acrylic.

Effect of crystallinity :

MPs and PP are greatly influenced by the degree of crystallinity :

As it increases : Polymer become stiffer harder, less ductile, more dense, less rubbery, and more resistance to solvent and heat

LDPE

60% to 70% crystallinity,

sp. gravity = **0.910 to 0.925**

HDPE

80% to 95% crystallinity,

sp. gravity = **0.941 to 0.970**

LDPE stronger, stiffer, tougher, less ductile than HDPE

$$\% \text{ Crystallinity} = \frac{\rho_c (\rho_s - \rho_a)}{\rho_s (\rho_c - \rho_a)} \times 100$$

ρ_c = Density of perfect crystalline polymer

ρ_a = Density of completely amorphous polymer

ρ_s = Density of partly crystalline polymer that we are analyzing

THERMAL PROPERTIES

Many plastics lose their strength at relatively low temp

~ no more than 150°C

Newer plastic, such as polyamide resin ~ 500°C

Glass transition temp : polymer act as glass (cooling) or become rubbery-viscous (heating)

- Decreasing T ...
 - increases E
 - increases TS
 - decreases % EL
- Increasing strain rate...
 - same effects as decreasing T .

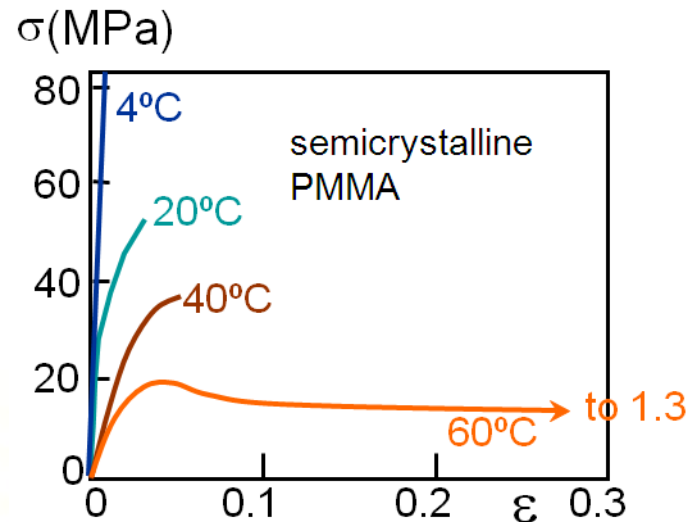

Glass transition temperature.

Temp at which - transition from hard, rigid, brittle and glassy at low temp to rubbery or leathery (high temp).

Example :

Determine mechanical properties of PVC at room temperature [$T_m = 212C$, $T_g = 87C$].

Representative T_g values ($^{\circ}C$):

PE (low density)	- 110
PE (high density)	- 90
PVC	+ 87
PS	+100
PC	+150

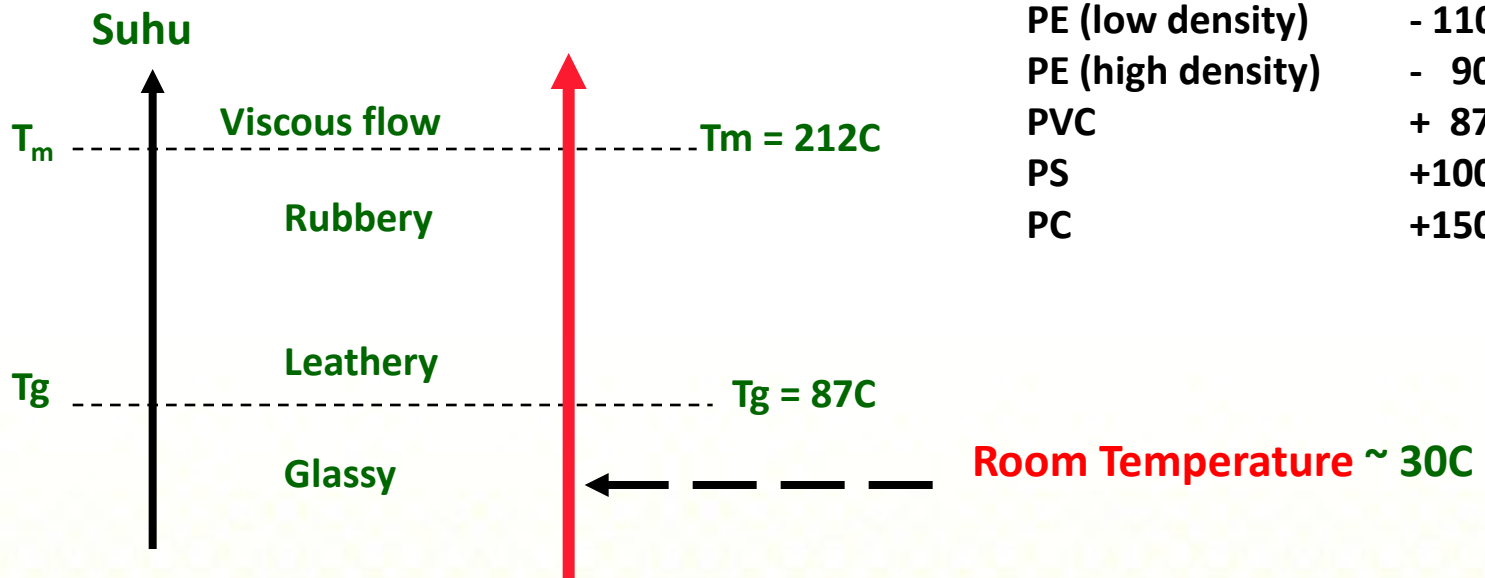

MECHANICAL PROPERTIES

i. Tensile properties

Incorporates two properties : viscosity and elasticity

Viscosity : refer to nature of a liquid's resistance to flow

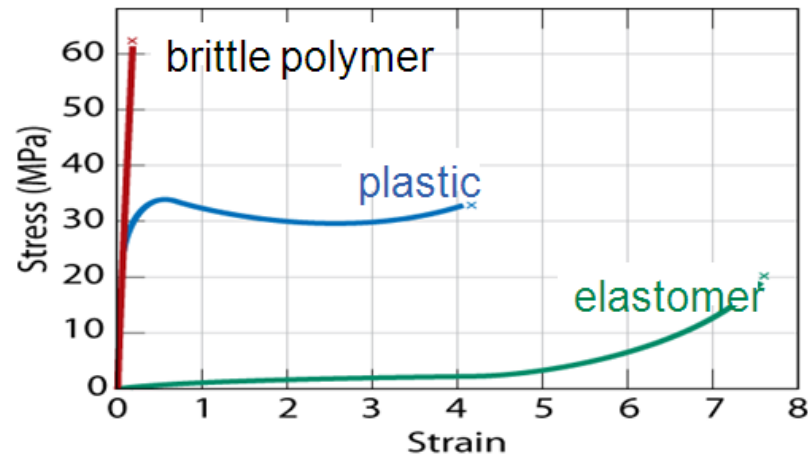

ii. Visco-elastic

Incorporates two properties : viscosity and elasticity

Viscosity : refer to nature of a liquid's resistance to flow

Elasticity : the ability of a material to return to its original size and shape one a load is removed.

Viscoelastic properties are determined by measuring the stress relaxation

- subjected to a constant strain at different temp

$$\sigma = \sigma_0 e^{-t/\omega}$$

σ = tegasan selepas masa t

σ_0 = tegasan awal

ω = masa santaian

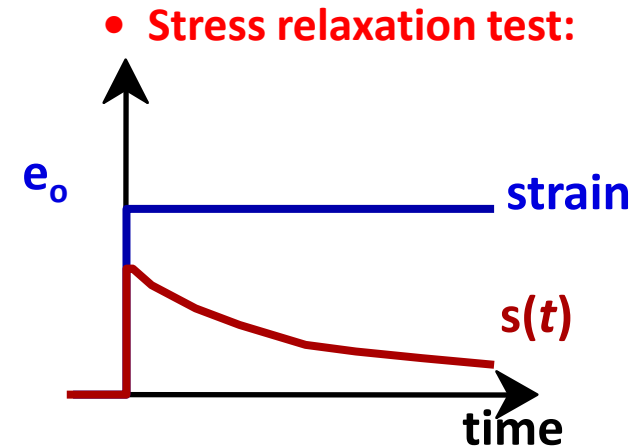

Question:

Stress of 1100psi is applied on a piece of rubber at a constant strain. After 40 days at the same temperature the stress decrease to 700psi. Determine :

- Relaxation time for this materials
- Stress retain in this materials after 60 days

Solution :

$$\text{i. } \ln(700/1100) = -40/\omega,$$

$$\omega = 88.5 \text{ hari}$$

$$\text{ii. } \ln(\sigma/1100) = -60/88.5,$$

$$\sigma = 559 \text{ psi}$$

Predeformation by Drawing

- Drawing
 - stretches the polymer prior to use
 - aligns chains in the stretching direction
- Results of drawing:
 - increases the elastic modulus (E) in the stretching direction
 - increases the tensile strength (TS) in the stretching direction
 - decreases ductility ($\%EL$)
- Annealing after drawing...
 - decreases chain alignment
 - reverses effects of drawing (reduces E and TS , enhances $\%EL$)
- Contrast to effects of cold working in metals!

Factors that influence Mechanical Properties

1. Temperature

2. Chain molecule bonding

Entanglement, strong inter-molecule bonding (van der Waals, cross-link) increase strength.

3. Drawing.

Analog of work hardening in metal, Chain molecule become highly oriented (perpendicular to the chain alignment direction strength is reduced)

4. Heat Treatment (annealing)

- Change in crystalline size and order

i. Undrawn materials

- Increasing annealing temperature leads to
increase in elastic modulus
increase in yield strength
decrease in ductility

(these changes are **opposite from metals**)

ii. Drawn materials

- Opposite changes
- due to recrystallization and
loss of chain orientation

Time-Dependent Deformation

- Relaxation modulus:

$$E_r(t) = \frac{\sigma(t)}{\epsilon_0}$$

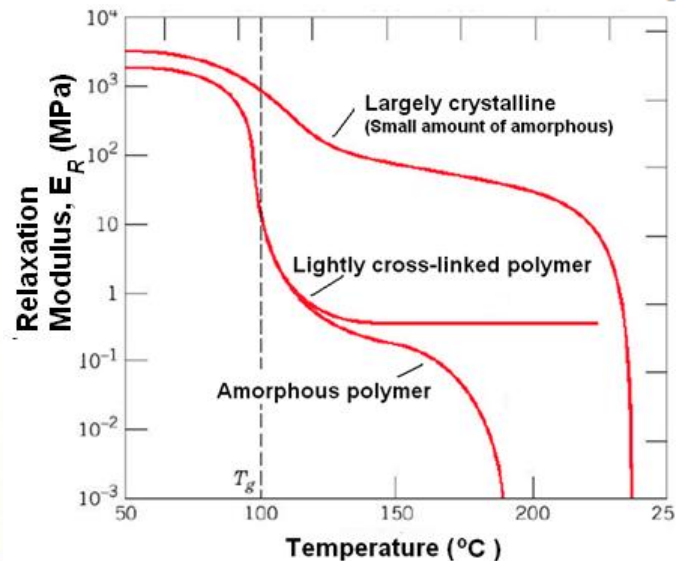
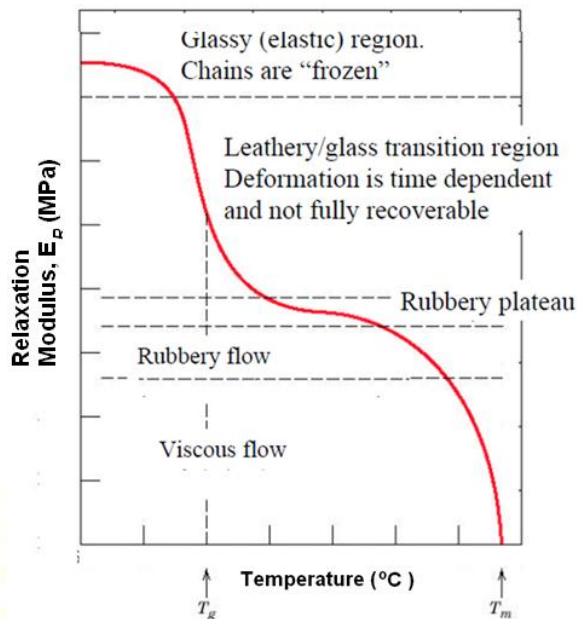
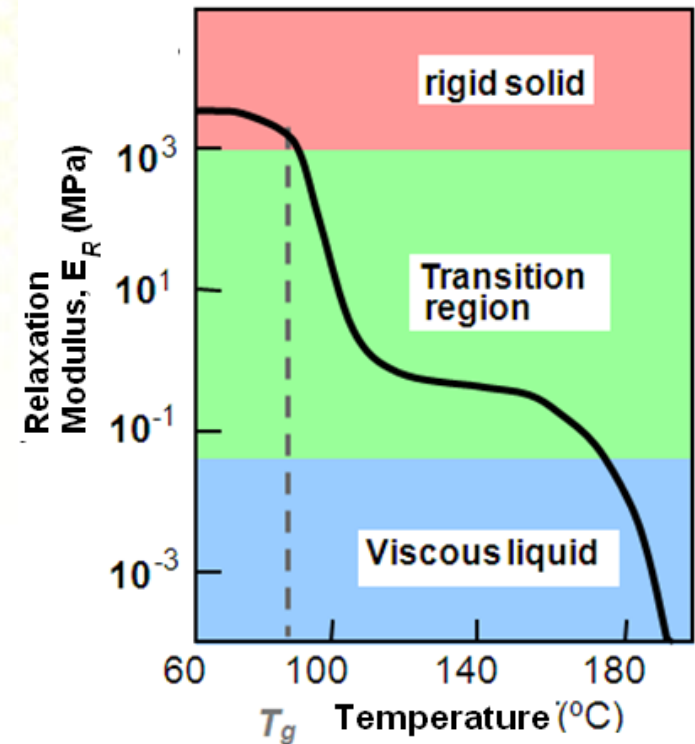

Effect of cross-link on E_R

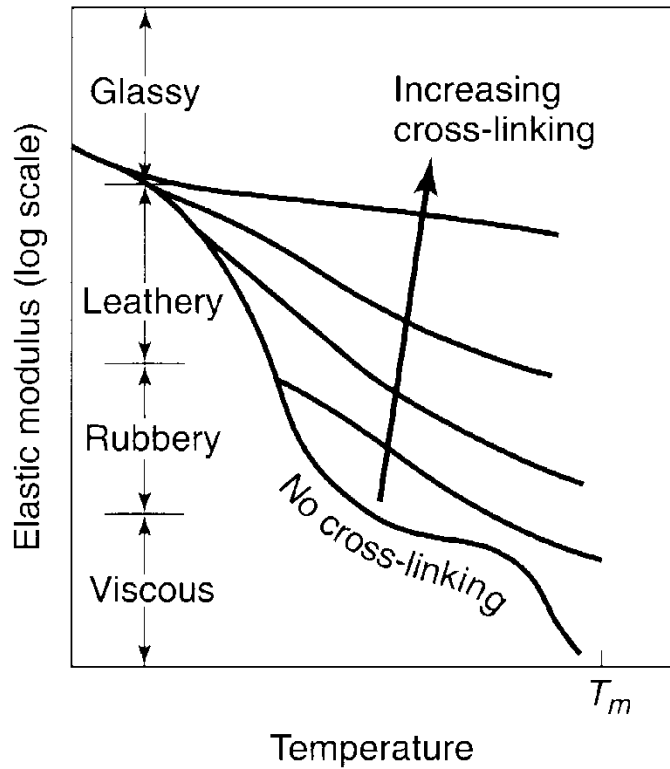

(b)

Effect of degree of crystallinity on E_R

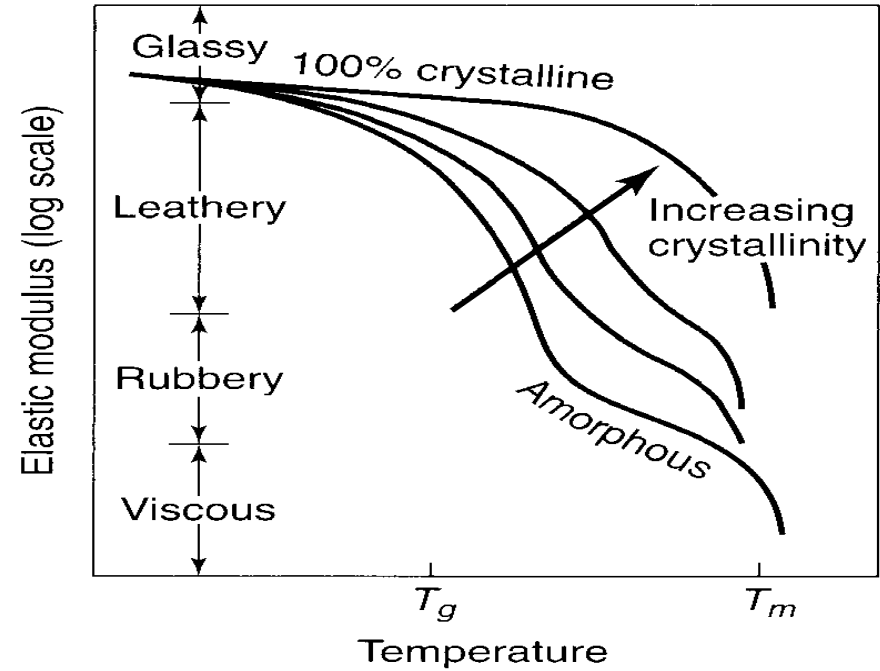

Methods to improve the strength of polymer

i. increases molecular weight

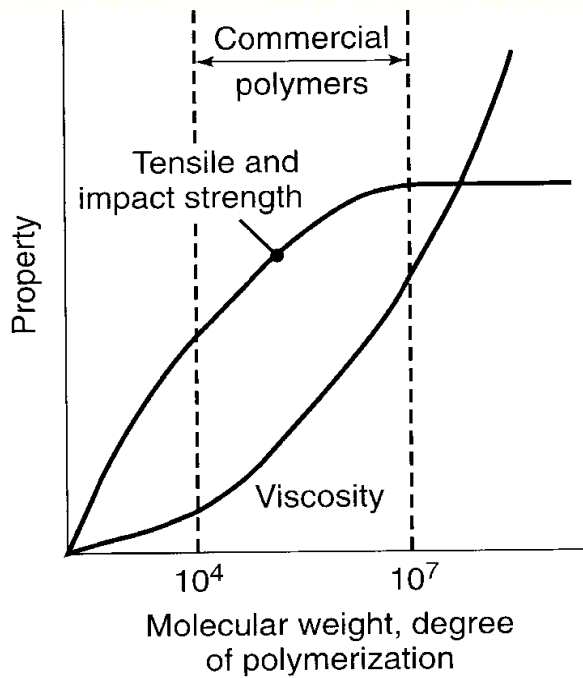

ii. increases DP

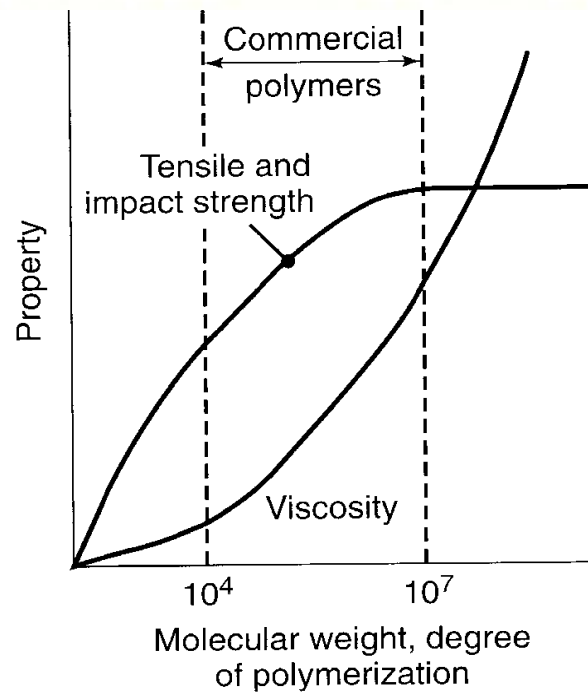

iii. increases % of crystallinity

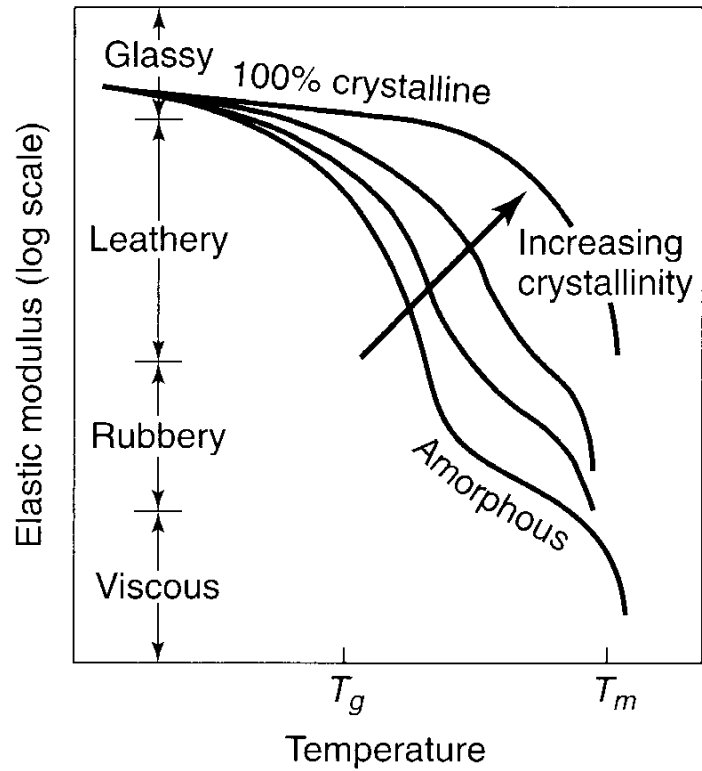

iv. Increases degree of vulcanisation

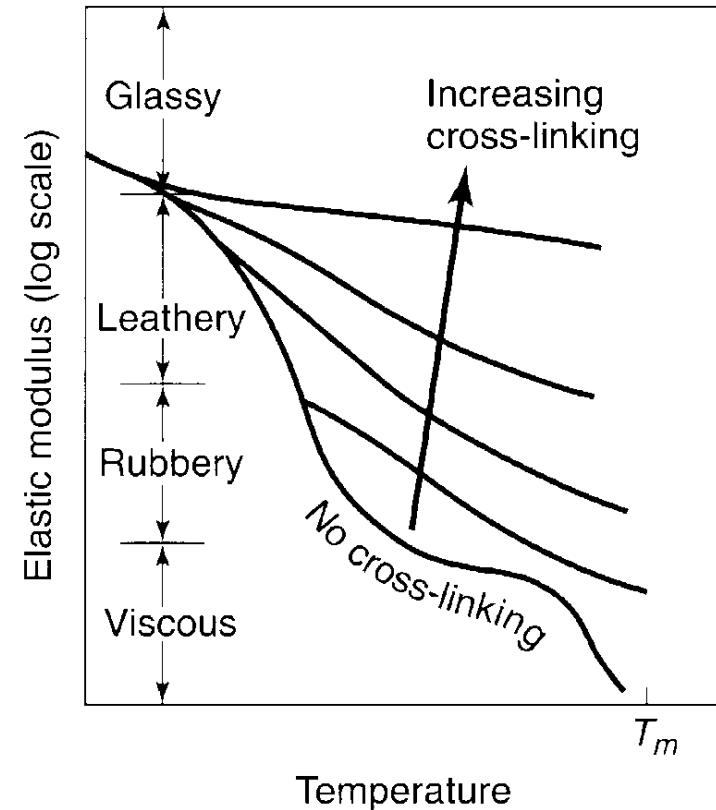

PLASTIC PROCESSING

Intelligent Processing of Materials (IPM)

Involves placing non-destructive evaluation (NDE) sensors in the processing equipment

- to allow computer monitoring and adaptive control (mixture, temp, pressure etc)
- to control the complex variables matched against the complex process model or expert system.

IPM leads itself to the trend for total quality management (TQM) and statistical process control (SPC)

- Technique associated with **improved quality in manufacturing product and reduced waste and overall cost.**

Thermoplastic

Needs heat and pressure for melting process and **cooling system**

Example : **casting**, **extrusion**, **injection blow moulding**, drawing, foaming, **thermoforming**, **rolling**, **callendering**, **rotational** and **resin transfer moulding**.

Thermosetting :

Needs heat and pressure

Example : **casting**, **spraying**, **compression moulding**, **transfer moulding** and **reaction injection moulding**. Etc.

Raw plastic : grain, powder, bead, flake & plate, tube, rod etc.



ADDITIVES

To impart certain properties : **modify and improve stiffness, strength, color, weatherability, flammability, and ease of processing.**

Polymer Additives

Improve mechanical properties, processability, durability, etc.

- **Fillers**

- Added to improve tensile strength & abrasion resistance, toughness & decrease cost

- **Example**

carbon black, silica gel, wood flour, glass, limestone,
clay, serbuk kaca & asbestos

Plasticizers

Added to reduce the T_g below room temperature

- Presence of plasticizer transforms brittle polymer to a ductile one
- Commonly added to PVC - otherwise it is brittle

Example : **vinyl aetate**

- **Stabilizers**

- Antioxidants
- UV protectants

Example : **Black carbon**

- **Lubricants**

- Added to allow easier processing
- polymer “slides” through dies easier
- **example :**
sodium stearate, fatty acid, paraffin

- **Colorants**

- Dyes and pigments

- **Flame Retardants**

- Substances containing chlorine, fluorine, and boron

1. EXTRUSION MOULDING

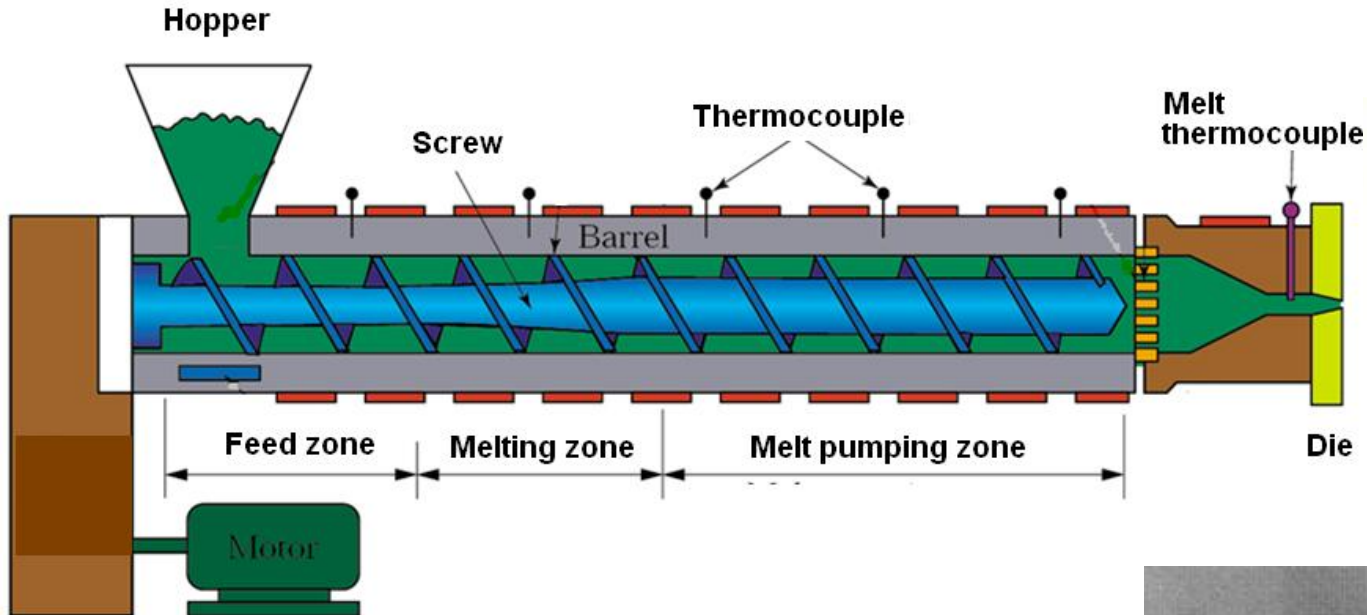

Storm water drainage system
60 in dia HDPE

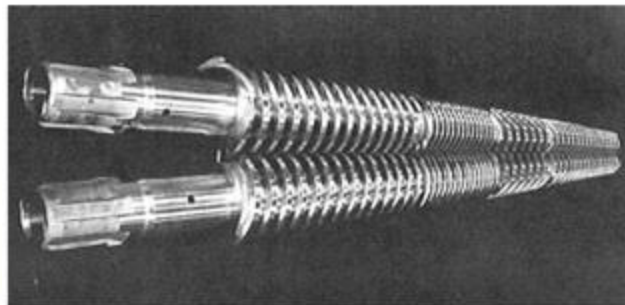

Twin extruder screw

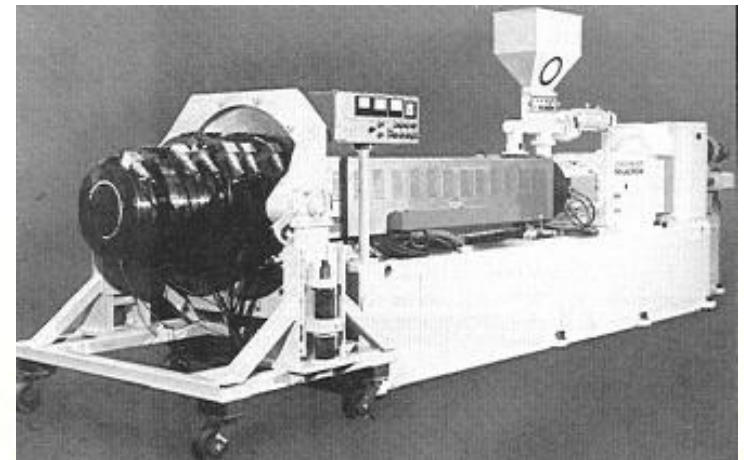

- plastic pellets drop from hopper onto the turning screw
- plastic pellets melt as the turning screw pushes them forward by the heaters
- molten polymer is forced under pressure through the shaping die to form the final product (extrudate)

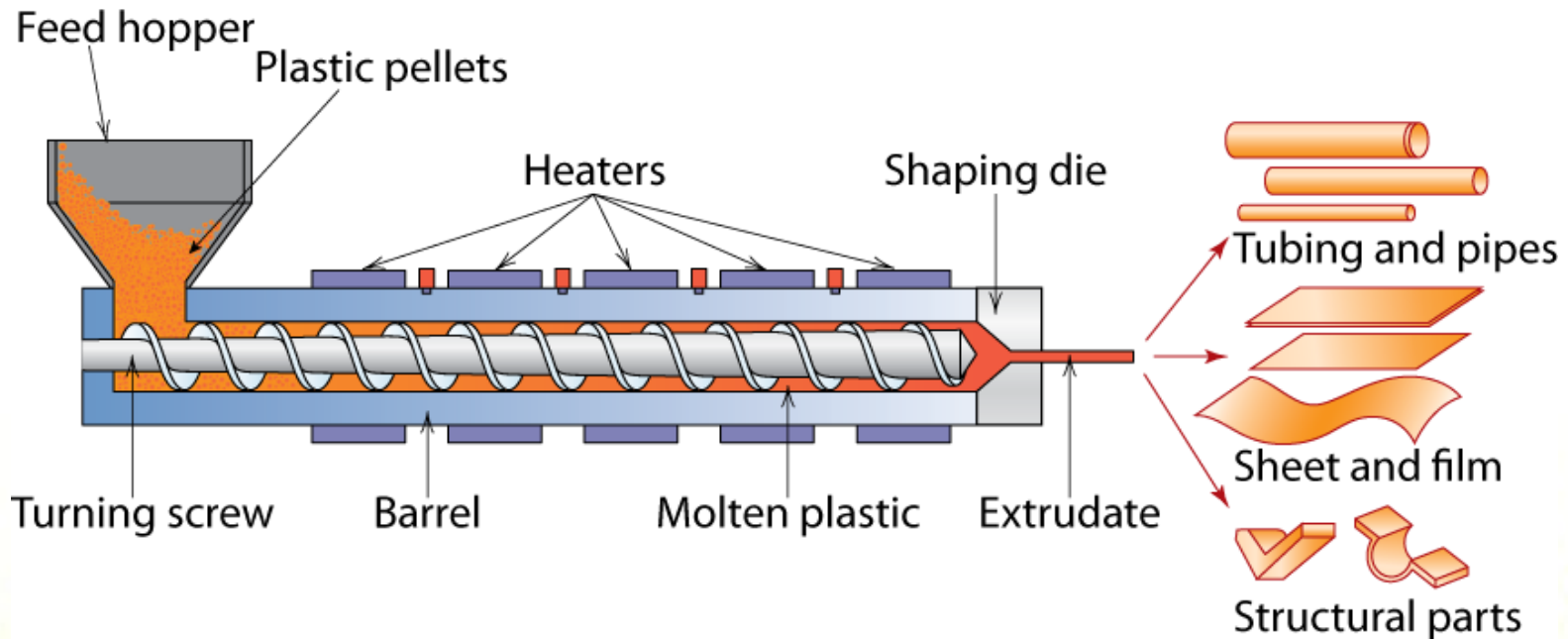

Blown-Film Extrusion

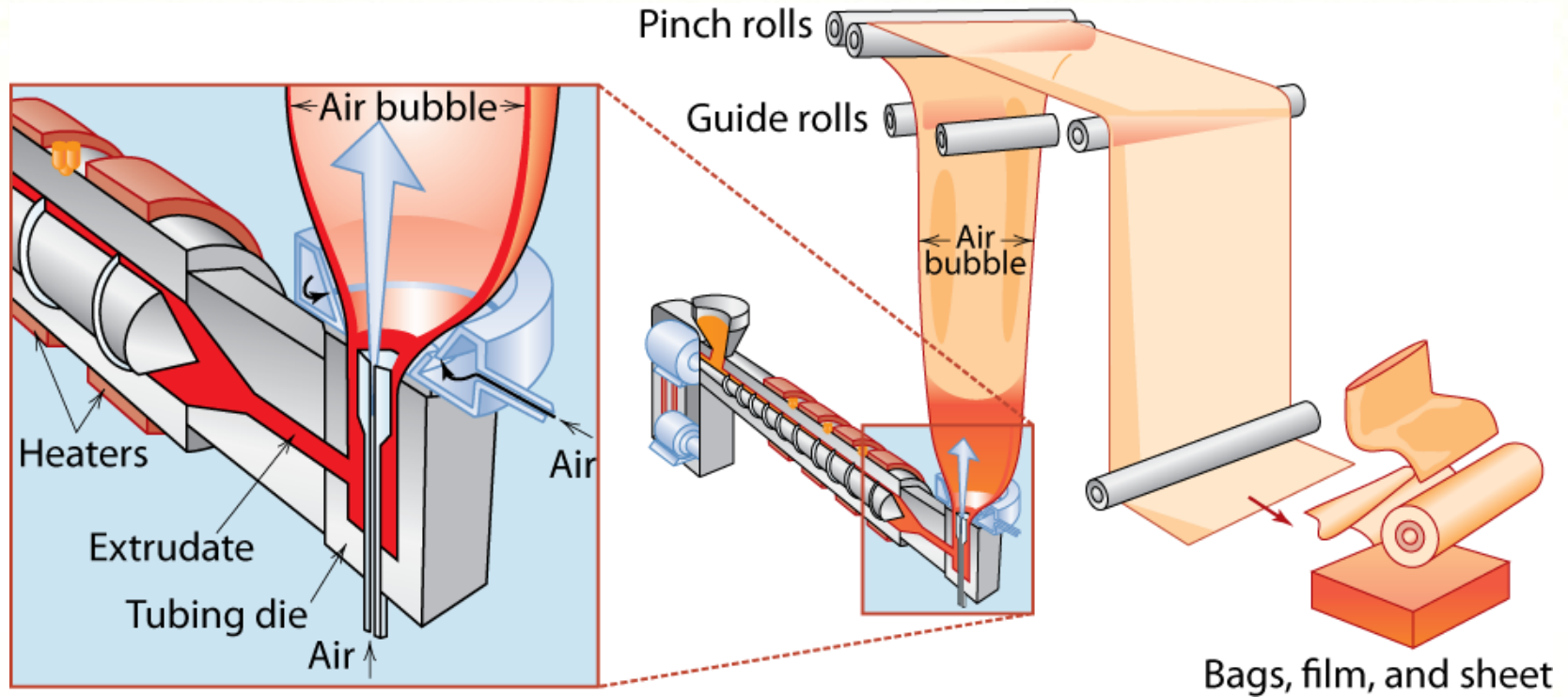

Dies are not a component of the extruder and must be designed and fabricated for the particular profile to be produced

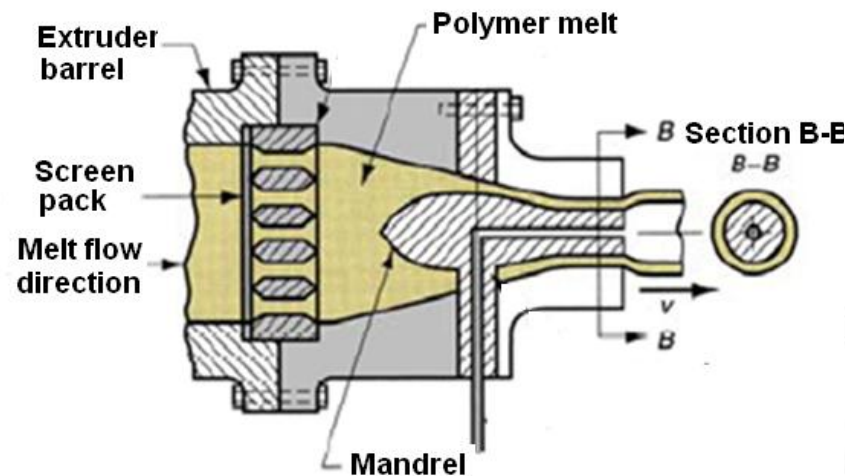

Hollow Profiles

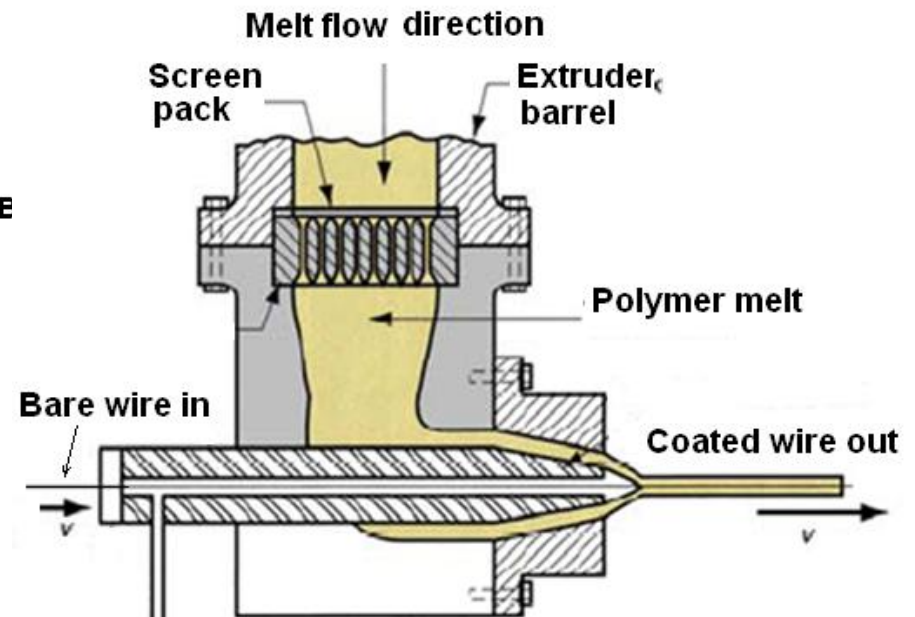

Extruding a Coated Wire

2. INJECTION MOULDING

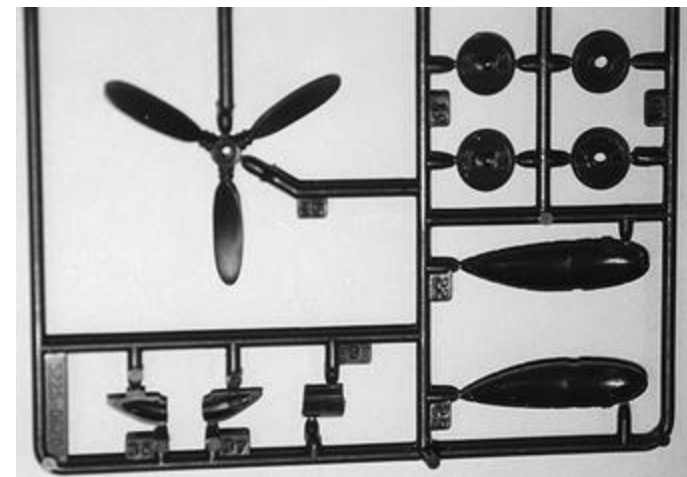
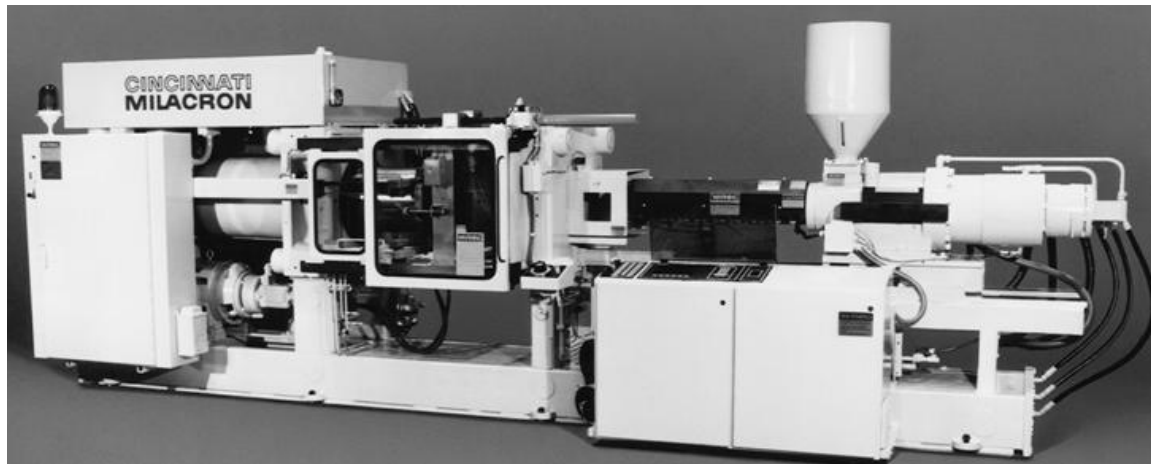
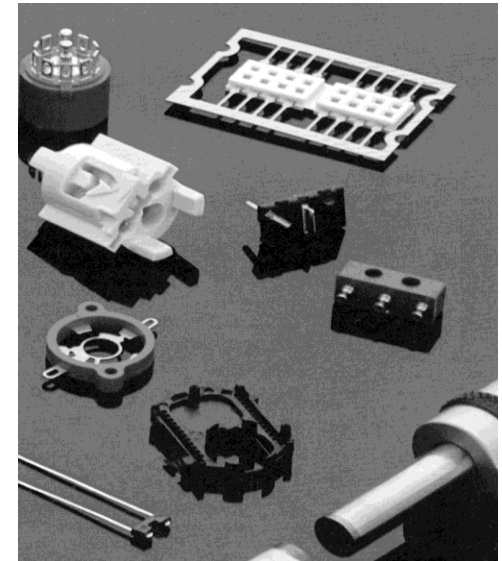
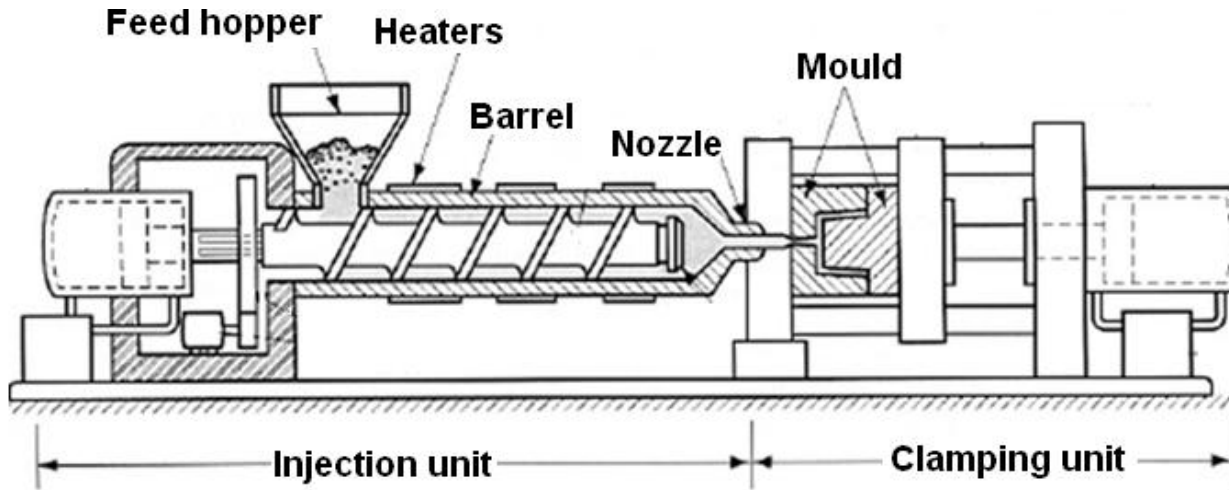

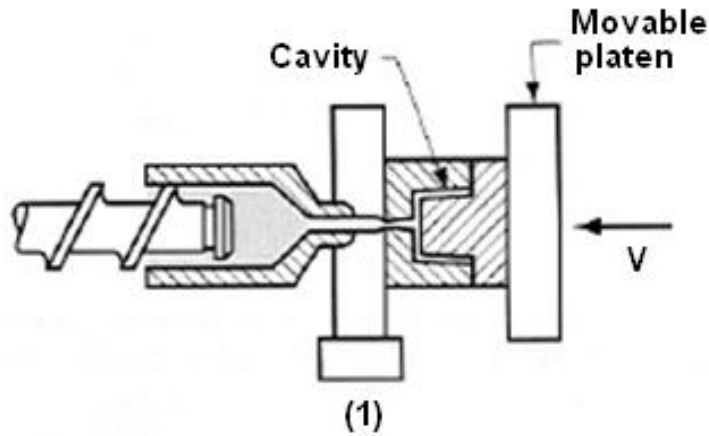

Thermoplastics and some thermosets

- when ram retracts, plastic pellets drop from hopper into barrel
- ram forces plastic into the heating chamber (around the spreader) where the plastic melts as it moves forward
- molten plastic is forced under pressure (injected) into the mold cavity where it assumes the shape of the mold
- The production moulding cycle time is in the range of 10 to 30 sec.

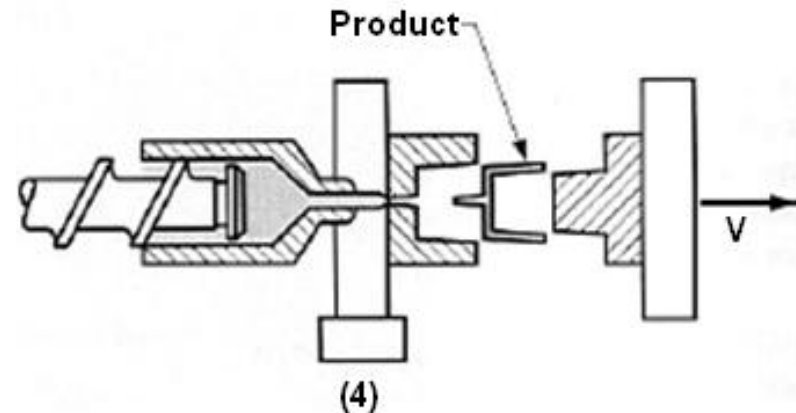
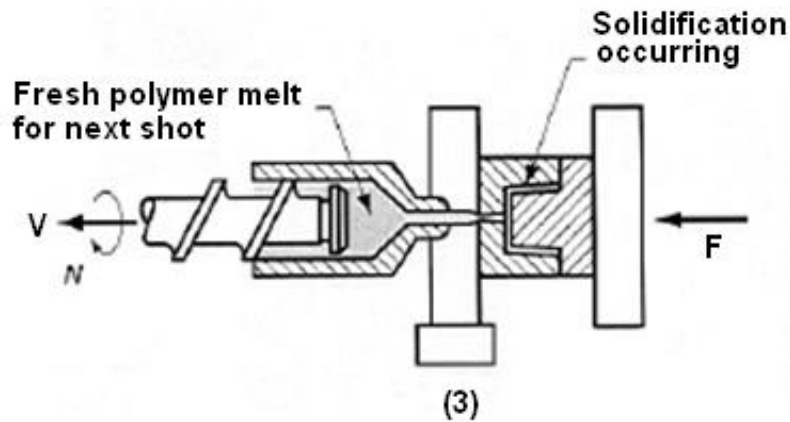
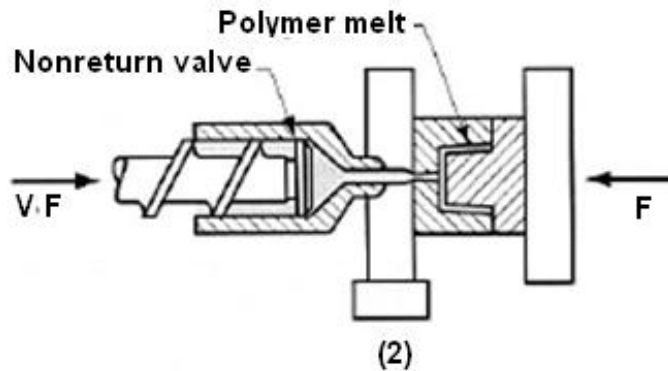

3. COMPRESSION MOULDING.

Thermoplastics and thermosets

- polymer and additives (Pre-shaped part of preform) is placed in mold cavity
- mold heated and pressure applied
- fluid polymer assumes shape of mold

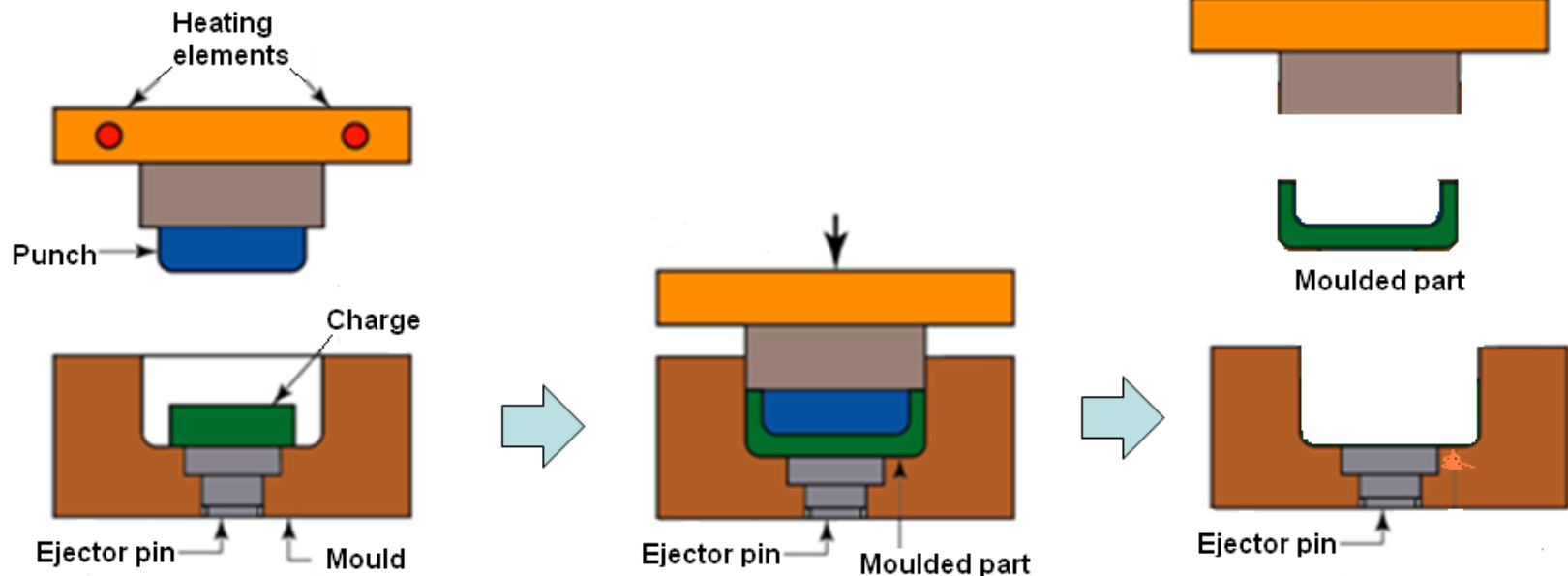

4. BLOW MOULDING

Blowing is done with a hot-air blast at pressure of 350-700 kPa.

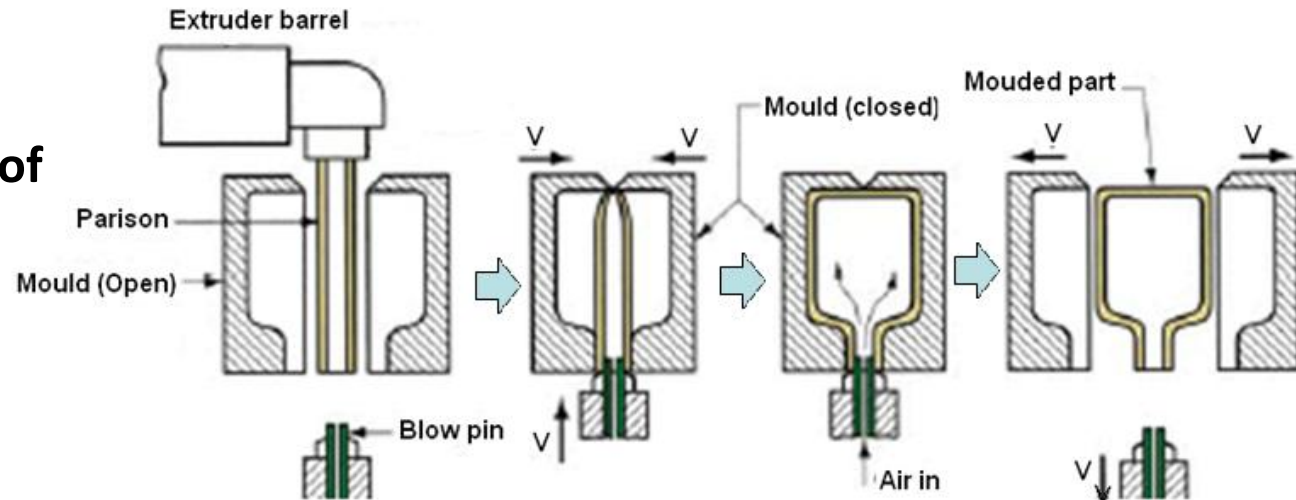

5. CALENDERING

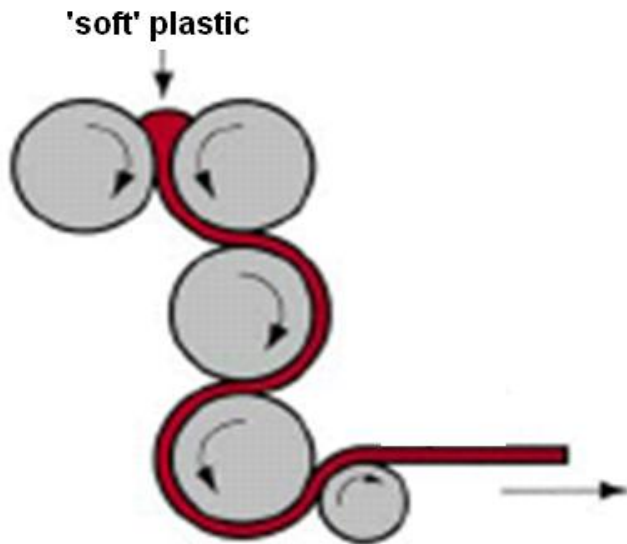

Usually used for rubber and thermoplastic materials (eg : plasticized PVC)

Eg : PVC floor covering, shower curtains, vinyl table, cloths, pool liners, and inflatable boats and toys

6. THERMOFORMING PROCESS

Various thermoforming processes for thermoplastic sheet.

These processes are commonly used in making :

- advertising signs, toys, boat hulls, bath tabs, trays, panels for shower stalls, and packaging.

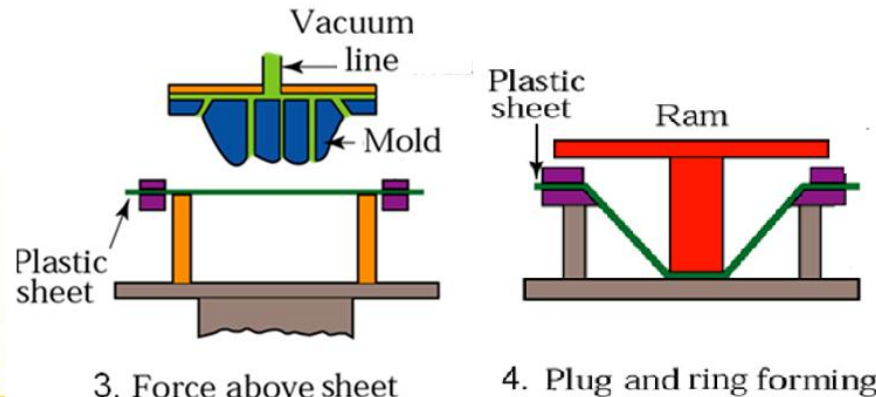
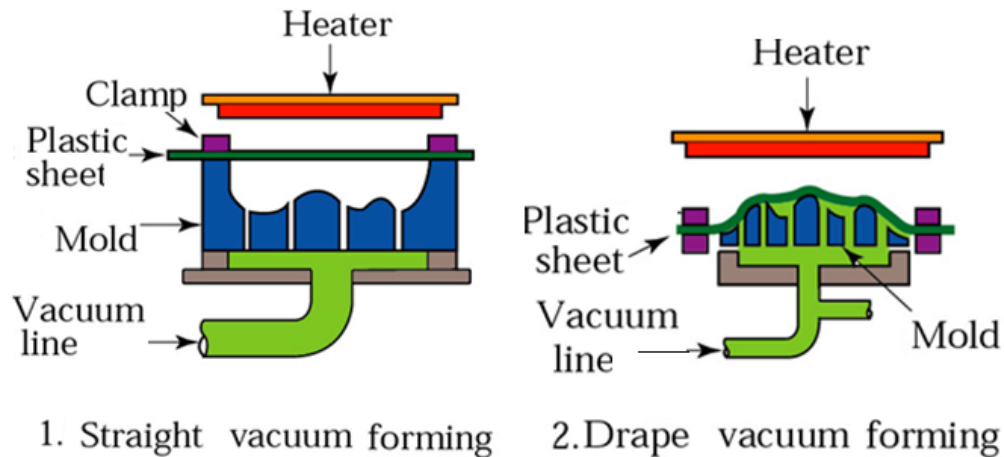

RUBBER

POLYISOPRENE (C_5H_8)_n

- Elastomer

- Synthetic rubber ; copolymer,

GR-A : Butadiene + Acrilotrile

GRS-S : Butadiene + styirena

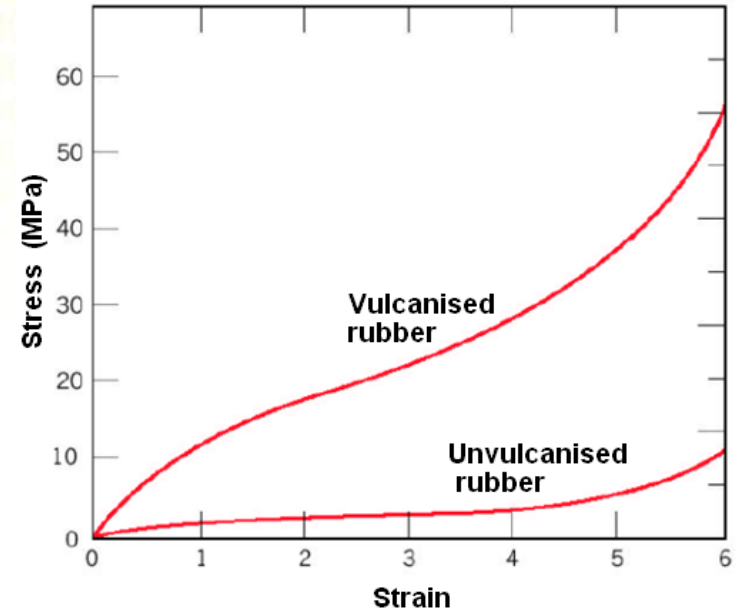
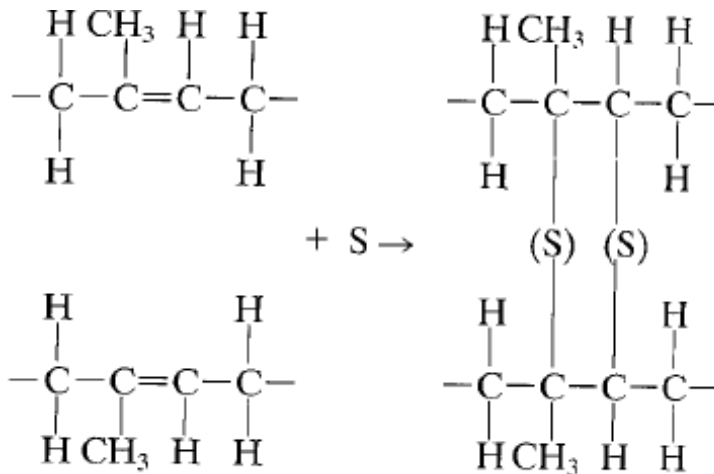
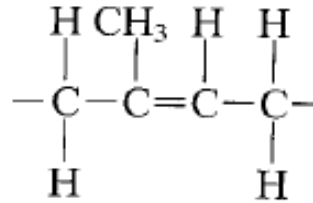

- MPs rubber can be further increased by **VULCANISATION**

- **Cross-link** to chain molecule structure

Example

SBR synthetic rubber is to be produced with the addition of 2 styrene mers (C_8H_8) and 6 butadiene mers (C_4H_6). Calculate the weight percentage of sulphur needed to form 22% cross-link in the rubber. [$a_C = 12$, $a_H = 1$, $a_S = 32$ g/mol]

Answer :

Molecular weight :

Styrene : $8(12) + 8(1) = 104$ g/mol

Butadiene : $4(12) + 6(1) = 54$ g/mol

Number of mer :

$= 2(S) + 6 (B)$

$= 8.$

Average molecular weight = $2/8(104) + 6/8(54) = 66.5$ g/mol

For example 100g copolymer to be produced :

$100g/66.5g/mol = 1.51$ mol

Weight of Sulphur for 22% crosss-link: = $0.22 \times 32 = 10.6$ gram

Weight % of sulphur = $10.6/10.6 + 100 \times 00 = 9.5\%$

References

- K. G. Budinski and M.K. Budinski, Engineering Materials, Properties and Selection, 9th Ed, Pearson and Prentice Hall, 2010
- J. F. Shackelford, Introduction to Materials Science for Engineers, 6th Ed., Pearson and Prentice Hall, 2005.
- J.A. Schey, Introduction to Manufacturing Process, 3rd Ed., Mc Graw Hill, 2000.
- J. A. Jacobs and T. F. Kilduff, Engineering Materials and Technology, Structure, Processing, Properties and Application, 5th ed., Pearson & Prentice Hall, 2005.
- G. E. Dieter, Mechanical Metallurgy, McGraw-Hill, 3rd ed., 1991
- W. D. Callister, Mater. Science and Engineering – An Introduction, 8th ed., John Wiley & sons, Inc, 2011
- W. F. Smith, Principles of Materials Science and Engineering, 4rd ed., McGraw Hill, 2007.